

INSTRUCTION MANUAL
NON-MYDRIATIC RETINAL CAMERA

TRC-NW8

INTRODUCTION

Thank you for purchasing the TOPCON TRC-NW8 NON-MYDRIATIC RETINAL CAMERA.

This instrument is used to observe and photograph the fundus of the eye.

This instrument has the following features:

- Photographs can be taken through pupils ϕ 4.0mm or larger. (ϕ 3.3mm or larger if small pupil diaphragm is on)
- Auto focus function
- Red-free photography with red-free filter (RF filter)

This manual outlines the TRC-NW8 NON-MYDRIATIC RETINAL CAMERA, including operating procedures, troubleshooting, maintenance and cleaning. Before using the instrument, carefully read the "DISPLAY FOR SAFE USE" and the "SAFETY CAUTIONS" to familiarize yourself with the features of the TRC-NW8 NON-MYDRIATIC RETINAL CAMERA and use it efficiently and safely. Always keep this Instruction Manual at hand.

[Warning]

Be careful not to hit the patient's eyes or nose with the instrument during operation.

[The patient may be injured.]

[Caution]

This instrument must not be used for the following patients.

- Patients who are hypersensitive to light
- Patients who recently underwent photodynamic therapy (PDT)
- Patients taking medication that causes photosensitivity.



This symbol is applicable for EU member countries only. To avoid potential negative consequences for the environment and possibly human health, this instrument should be disposed of (i) for EU member countries - in accordance with WEEE (Directive on Waste Electrical and Electronic Equipment), or (ii) for all other countries, in accordance with local disposal and recycling laws.

This product contains a CRL Litium Battery which contains Perchlorate Material-special handling may apply.

See <http://www.dtsc.ca.gov/hazardouswaste/perchlorate/>

Note;This is applicable to California,U.S.A.only

CLASS I

IEC60601-1

0123

CAUTIONS FOR USE

Important cautions

Use this instrument carefully on the following patients.

- Patients who have epidemic keratitis, conjunctivitis or any other infectious disease
- Patients who are taking medications that cause light hypersensitivity.

Basic cautions

Be careful not to let the patient touch this instrument. The patient's hand may be pinched by the movable part.

Do not touch the focusing knob while in auto focus mode. You may be injured.

When operating the chinrest switch, be careful not to pinch the patient's hand. The patient may be injured.

To avoid electric shock, turn off the power switch when replacing the lamp.

To avoid burns, do not replace the lamp with a new one immediately after it goes off because it is still very hot and can cause burns.

To avoid injury caused by electric shock, do not open the cover. Ask your dealer for service.

To avoid electric shock, turn off the power switch and unplug the power cord and then replace the lamp with a rated one.

Disposal

When disposing of TRC-NW8 parts, follow the local regulations for disposal and recycling.

ENVIRONMENTAL CONDITIONS FOR USE

Temperature : 10°C - 40°C

Humidity : 30% - 90% (without dew condensation)

Air pressure : 700hPa - 1060hPa

STORING PLACE, USAGE PERIOD AND OTHERS

1. Environmental conditions (without package)

*Temperature : 10°C - 40°C

Humidity : 10% - 95% (without dew condensation)

Air pressure : 700hPa - 1060hPa

* THIS INSTRUMENT DOES NOT MEET THE TEMPERATURE REQUIREMENTS OF ISO 15004-1 FOR STORAGE. DO NOT STORE THIS INSTRUMENT IN CONDITIONS WHERE THE TEMPERATURE MAY RISE ABOVE 40°C OR FALL BELOW 10°C.

2. When storing the instrument, ensure that the following conditions are met:

(1) The instrument must not be splashed with water.

(2) Store the instrument away from environments where air pressure, temperature, humidity, ventilation, sunlight, dust, salty/sulfurous air, etc. could cause damage.

(3) Do not store or transport the instrument on a slanted or uneven surface or in an area where it is subject to vibrations or instability.

(4) Do not store the instrument where chemicals are stored or gas is generated.

3. Normal life span of the instrument:

8 years from delivery providing regular maintenance is performed [TOPCON data]

ENVIRONMENTAL CONDITIONS FOR PACKAGING IN STORAGE

Temperature : -20°C - 50°C

Humidity : 10% - 95%

ENVIRONMENTAL CONDITIONS FOR PACKAGING IN TRANSPORTATION

Temperature : -40°C - 70°C

Humidity : 10% - 95%

CHECKPOINTS FOR MAINTENANCE



1. Periodically inspect the instrument and its parts.
2. Before using the instrument again after a long period of inactivity, make sure that it operates safely and normally.
3. Be careful not to stain the objective lens with fingerprints, dirt, etc., as this will affect the quality of pictures that the instrument takes.
4. When the instrument is not in use, cap the objective lens and cover the instruments with the dust cover.
5. If the objective lens is stained, clean it according to "Cleaning the objective lens" on page 80 of this manual.

DISPLAY FOR SAFE USE







To encourage safe and proper use and to prevent danger to the operator and others or potential damage to properties, important messages are put on the instrument body and inserted in the instruction manual.

We suggest that everyone understand the meaning of the following displays, icons and text before reading the "SAFETY CAUTIONS" and observe all listed instructions.

DISPLAYS









Display	Meaning
 WARNING	Incorrect handling by ignoring this display may lead to an impending danger of death or serious injury.
 CAUTION	Incorrect handling by ignoring this display may lead to personal injury or physical damage.
<ul style="list-style-type: none">• Injury refers to hurt, cuts, bruises, electric shock, etc. which does not require hospitalization or extended medical treatment.• Physical damage refers to extensive damage to the building, nearby equipment and/or surrounding furniture.	

ICONS

Icon	Meaning
	Prohibition. Specific content is expressed with words or a picture near the  icon.
	Mandatory Action Specific content is expressed with words or a picture near the  icon.
	Caution Specific content is expressed with words or a picture near the  icon.

SAFETY CAUTIONS

WARNINGS

Icon	Prevention item	Page
	To avoid fire and electric shock in case of leakage, be sure to use a grounded outlet. Do not connect to outlets that are not grounded.	22
	To avoid electric shock, do not attempt disassembling, rebuilding and/or repairs on your own. Ask your dealer for repairs.	63
	Do not remove the covers from the main unit, chinrest unit or power supply unit except for the lamp house cover. You may receive an electric shock.	63
	To avoid electric shock, unplug the power cord from the grounded outlet before removing the fuse cover. Do not connect the power cord to the grounded outlet with the fuse cover left unfixed.	76
	To avoid fire in the event of an instrument malfunction, use only fuses that are fitted to the marked label at the side of the fuse holder.	76
	To avoid fire and electric shock, install the instrument in a dry place free of water and other liquids.	—
	To avoid fire and electric shock, do not put cups or other containers with liquids near the instrument.	—
	To avoid electric shock, do not insert metal objects into any vents and/or slots.	—
	To avoid fire in the event of an instrument malfunction, immediately turn OFF the power switch "O" and unplug the cable if you see smoke coming from the instrument, etc. Ask your dealer for service.	—







CAUTION : Federal laws restricts this device to the sale by or on the order of a physician.

WARNING : Handling the cord on this product or cords associated with accessories sold with this product, will expose you to lead, a chemical known to the State of California to cause birth defects or other reproductive harm. **Wash hands after handling.**

This Product Contains Mercury in the backlighting of the LCD display. Prior to disposal remove of otherwise ensure that this is disposed of in accordance with Local, State and Federal Laws. This information is applicable in U.S.A only.









SAFETY CAUTIONS

⚠ CAUTIONS

Icon	Prevention item	Page
	To prevent damage and injuries, do not install the instrument on an uneven, unsteady or sloping surface.	18, 71
	To avoid electric shock, do not handle the plugs with wet fingers.	22
	To avoid pain and discomfort to the patient and damage to the patient's eye, do not brighten the illumination lamp more than necessary.	39
	To avoid pain and discomfort to the patient and damage to the patient's eye, do not brighten the photography light more than necessary.	40
	To avoid injury while moving the instrument, do not place your fingers into the gap between the instrument body and the power supply unit.	42
	To avoid burns, allow lamp to cool before touching.	73
	To avoid electric shock, do not touch the xenon lamp immediately after it flashes or burns out.	74

SAFETY CAUTIONS

CAUTIONS

Icon	Prevention item	Page
	Before transporting this instrument, secure the fixing knob on the bottom to prevent movements.	18
	This instrument should be carried by two persons. Carrying by one person may cause backache or injury. Holding at areas other than the bottom may also cause injury, as well as falling, thereby damaging the instrument.	18
	To avoid electric shock, unplug the power cord from the outlet before assembling. Do not plug the power cord into the outlet before assembling the instrument.	18
	To avoid injury to the patient's face and hands, be sure to operate the chinrest for height adjustment while directly watching the patient.	37
	To avoid injury to the patient's eyes and nose while moving the instrument body, keep a safe distance between the patient and the objective lens.	42
	To avoid injury by falling off, make sure that the digital camera is correctly installed.	71
	To avoid electric shock, be sure to turn the power switch off and unplug the power cord before replacing the lamp.	73, 74
	Always place and transport the instrument on a suitable instrument table.	—
	This instrument has been tested (with 100/120/230V) and found to comply with IEC60601-1-2: Ed.3.0: 2007. This instrument radiates radio frequency energy within standard and may affect other devices in the vicinity. If you have discovered that turning on/off the instrument affects other devices, we recommend you change its position, keep a proper distance from other devices, or plug it into a different outlet. Please consult your authorized dealer if you have any additional questions.	—

USAGE AND MAINTENANCE

Usage:

- The TRC-NW8 NON-MYDRIATIC RETINAL CAMERA is an electric instrument for medical use. Use it accordingly.

USER MAINTENANCE

To ensure the safety and performance of the instrument, all maintenance work, unless specified in this manual, shall only be conducted by trained service engineers.

The following maintenance tasks may be done by the user.

For details, see the relevant part of this manual.

Replacing lamps:

The illumination lamp and xenon lamp may be replaced by the user. For details, see "Replacing the illumination lamp" on page 73 and "Replacing the xenon lamp" on page 74.

Replacing fuses:

Fuses of the instrument body may be replaced by the user. For details, see "Changing the fuse" on page 76.

Cleaning the objective lens:

The objective lens may be cleaned by the user. For details, see "Cleaning the objective lens" on page 80.

ESCAPE CLAUSES

- TOPCON shall not take any responsibility for damage due to fire, earthquakes, actions by third persons and other accidents, or damage due to negligence and misuse by the user and any use under unusual conditions.
- TOPCON shall not take any responsibility for damage derived from inability to properly use this instrument, such as loss of business profit and suspension of business.
- TOPCON shall not take any responsibility for damage caused from using this instrument in a manner other than that described in this Instruction Manual.
- Diagnoses made shall be the responsibility of pertaining doctors and TOPCON shall not take any responsibility for the results of such diagnoses.

WARNING DISPLAYS AND POSITIONS

To ensure safety, this machine provides warning displays.

Use the instrument correctly by observing the display instructions. If any of the following display labels are missing, contact your TOPCON dealer at the address listed on the back cover.

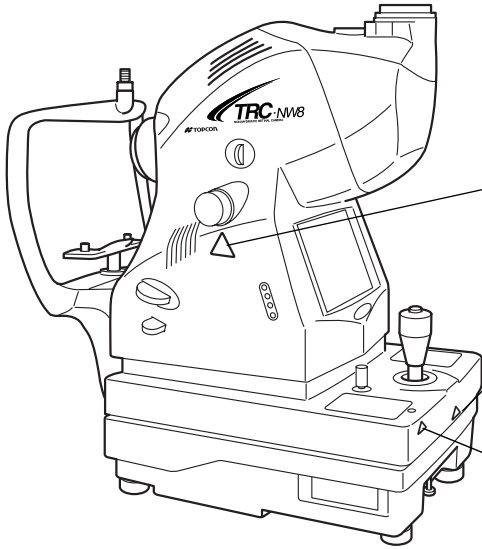

CAUTION
Do not touch the focusing knob while in auto focus mode. You may be injured.

CAUTION
Be careful not to hit the patient's eyes or nose with the instrument during operation.

CAUTION
When operating the chinrest switch, be careful not to pinch the patient's hand. The patient may be injured.

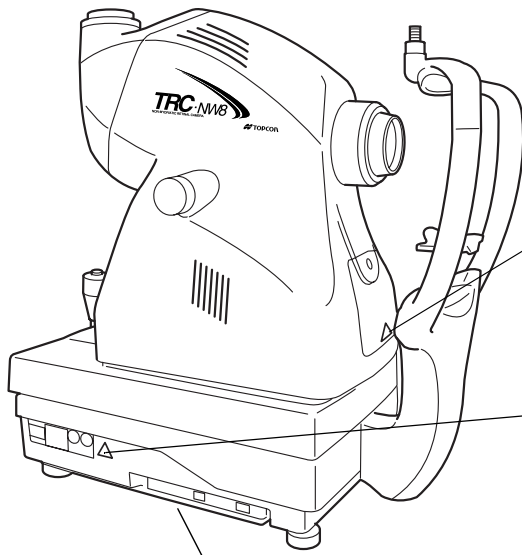

CAUTION

- To avoid electric shock, turn off the power switch when replacing the lamp.
- To avoid burns, do not replace the lamp with a new one immediately after it goes off because it is still very hot and can cause burns.

WARNING
To avoid electric shock, turn off the power switch and unplug the power cord and then replace the lamp with a rated one.

WARNING
To avoid injury caused by electric shock, do not open the cover. Ask your dealer for service.

CONTENTS

INTRODUCTION	1
CAUTIONS FOR USE	2
ENVIRONMENTAL CONDITIONS FOR USE	2
STORING PLACE, USAGE PERIOD AND OTHERS	2
ENVIRONMENTAL CONDITIONS FOR PACKAGING IN STORAGE	3
ENVIRONMENTAL CONDITIONS FOR PACKAGING IN TRANSPORTATION	3
CHECKPOINTS FOR MAINTENANCE	3
DISPLAY FOR SAFE USE	4
SAFETY CAUTIONS	5
USAGE AND MAINTENANCE	8
ESCAPE CLAUSES	8
WARNING DISPLAYS AND POSITIONS	9

NOMENCLATURE

COMPONENT NAMES	12
COMPOSITION OF PARTS THAT COME IN CONTACT WITH THE PATIENT	12
CONTROL PANEL COMPONENTS	13
COMPONENTS ON COLOR LCD MONITOR SCREEN	15
STANDARD ACCESSORIES	17

PREPARATIONS

ASSEMBLY PROCEDURE OF THE INSTRUMENT BODY	18
INSTALLING THE DIGITAL CAMERA	20
HOW TO CONNECT THE CABLES	20
CONFIRMATION AFTER ASSEMBLY	21
CONNECTING THE POWER CORD	22
CONNECTING THE EXTERNAL DEVICE	23
MENU SETTING	25
SETTING THE RECORDING MEDIUM TO SAVE IMAGE	31
RESET FROM POWER SAVE STATE	35

BASIC OPERATIONS

FLOW OF OPERATION	36
OTHER TYPES OF PHOTOGRAPHY	36
PREPARATION FOR PHOTOGRAPHY	37
COLOR PHOTOGRAPHY (CENTER)	39
EXITING	47

OBJECTIVE OPERATIONS

PERIPHERAL PHOTOGRAPHY	48
SMALL PUPIL PHOTOGRAPHY	52
RED-FREE PHOTOGRAPHY WITH RF FILTER	55
ANTERIOR SEGMENT PHOTOGRAPHY	56
STEREO PHOTOGRAPHY	58
IMAGE PLAYBACK MODE	60

BEFORE REQUESTING SERVICE

TROUBLESHOOTING	62
-----------------------	----

SPECIFICATIONS & PERFORMANCE

SPECIFICATIONS	65
ELECTROMAGNETIC COMPATIBILITY	66
ELECTRIC RATING	69
SYSTEM CLASSIFICATION	69
DIMENSIONS AND WEIGHT	70
PURPOSE OF USE	70
OPERATION PRINCIPLE	70

MAINTENANCE

DAILY CHECKUPS	71
CLEANING	80

OPTIONAL ACCESSORIES

EXTERNAL FIXATION TARGET EF-2	82
-------------------------------------	----

REFERENCE MATERIAL

SHAPE OF PLUG	83
SYMBOL	83
USABLE AUTOMATIC INSTRUMENT TABLE	83

RELATION BETWEEN SETTING OF ILLUMINATION/ FLASH LEVEL AND MAXIMUM RADIANCE

.....	84
INFORMATION ABOUT THE OPTICAL RADIATION HAZARD TO THE USER	85

NOMENCLATURE

COMPONENT NAMES

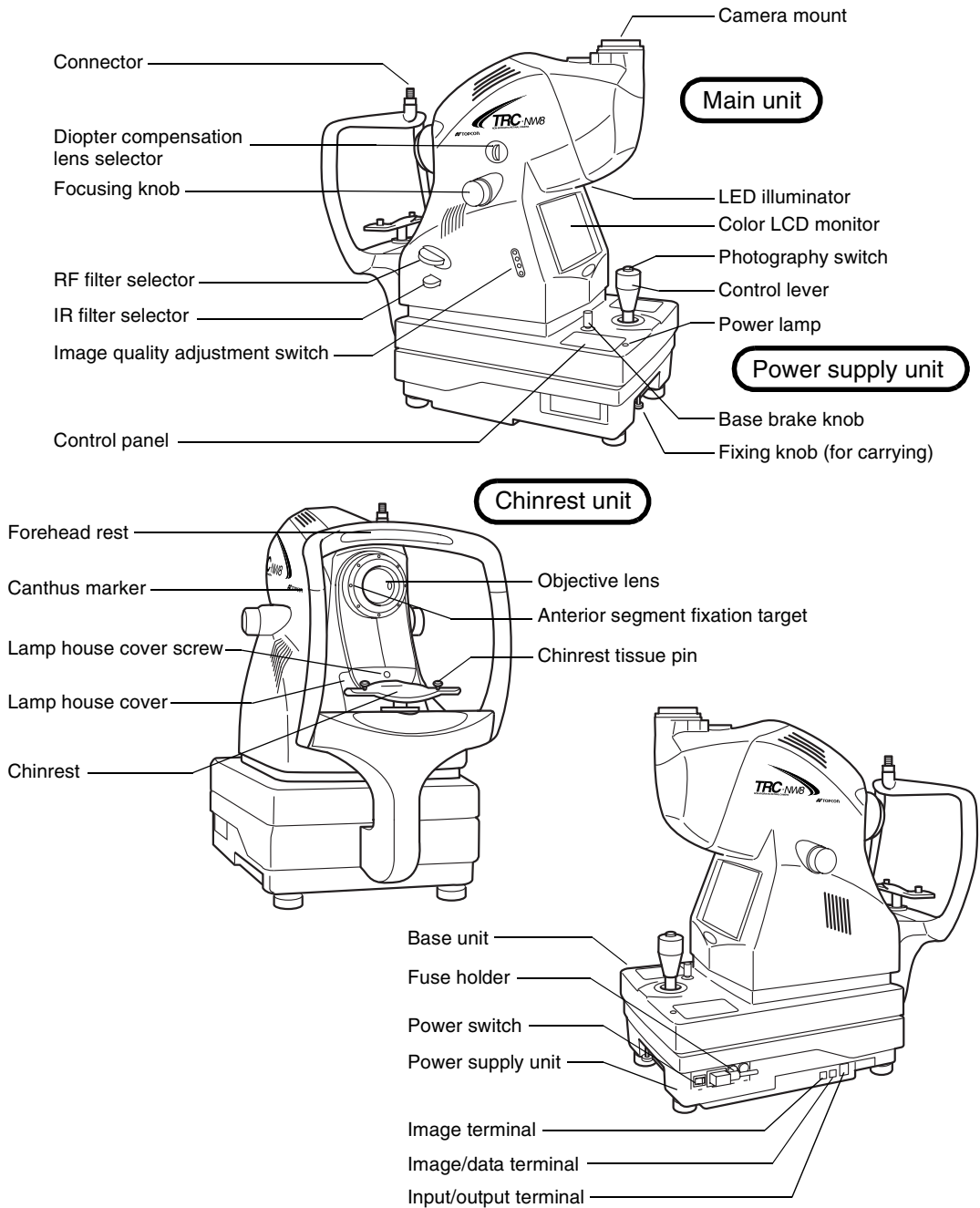

COMPOSITION OF PARTS THAT COME IN CONTACT WITH THE PATIENT

- Forehead rest : Silicone rubber
- Chinrest : Acrylonitrile butadiene styrene resin
- Chinrest tissue pin : Polyamide resin

CONTROL PANEL COMPONENTS

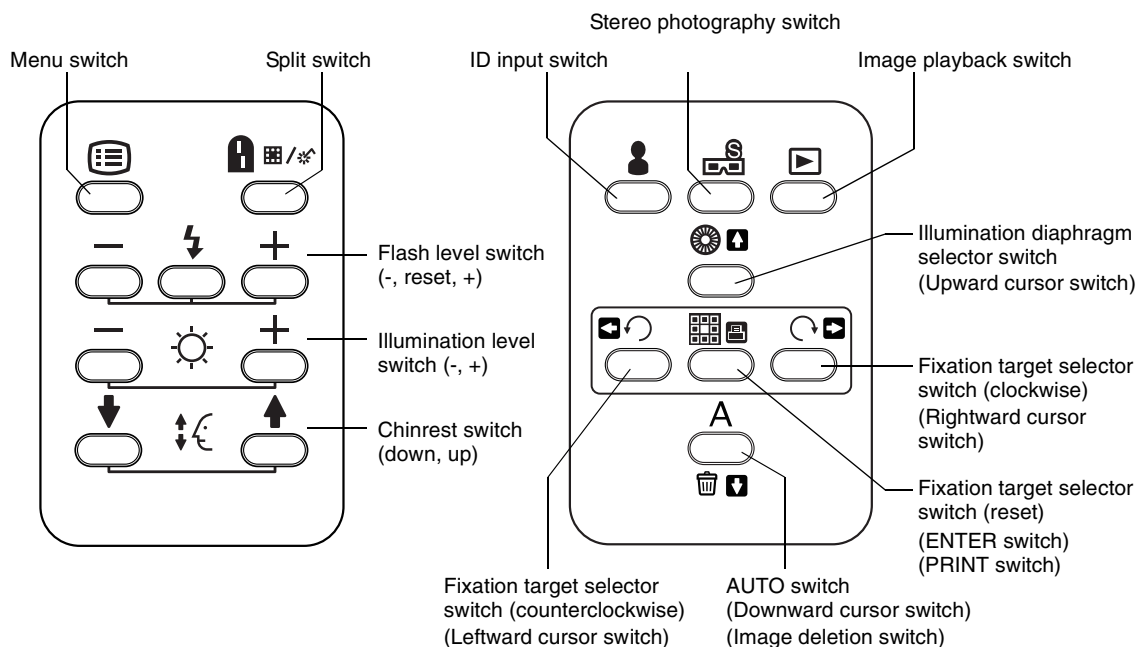

Menu switch: P.25

Displays "MENU".

Split switch: P.45

Turns on/off the split line.

* (The function of the split switch can be changed by setting. For example, this switch can be set in order to turn on/off the internal fixation target.)

Flash level switch: P.40

Adjusts the flash level according to the patient's eye condition.

Illumination level switch: P.39

Adjusts the illumination level according to the patient's eye condition.

Chinrest switch: P.38

Adjusts the chinrest up/down movement.

ID input switch: P.37

Moves to the ID input screen.

Image playback switch [Reading the image]: P.60

Reproduces the image stored in the set record media.

(This switch function is invalidated by the setting on the external recording device and the instrument.)

Illumination diaphragm selector switch: P.52

(Upward cursor switch): P.25, P.37

Used in small pupil photography. IN/OUT of the illumination diaphragm for small pupil (hereinafter, small pupil diaphragm) is done.

(You can move the selection cursor upward when entering the menu and ID.)

AUTO switch: P.45

(Downward cursor switch): P.25, P.37

(Image deletion switch [Deleting the image]): P.61

Turns ON/OFF the auto shoot/auto focus/auto small pupil functions. (ON/OFF of each function can be set by "MENU".)

(You can move the selection cursor downward when entering the menu and ID. Turns ON/OFF to delete the reviewed photographic image.)

Fixation target selector switch (counterclockwise): P.48

(Leftward cursor switch): P.37

Switches the position of the internal fixation target to guide the patient's eye to the periphery fixation point.

(You can move the selection cursor leftward when entering the menu and ID.)

Fixation target selector switch (clockwise): P.48

(Rightward cursor switch): P.37

Switches the position of the internal fixation target to guide the patient's eye to the periphery fixation point.

(You can move the selection cursor rightward when entering the menu and ID.)

Fixation target selector switch (reset): P.48

(ENTER switch): P.25, P.37

(PRINT switch): P. 60

Switches the current internal fixation target position to the first position.

(Turn ON this switch to print the reviewed image. Chooses the selected item in "MENU".)

Stereo photography switch: P.58

Shifts to the stereo photography mode.



* For details, contact your dealer or TOPCON (see the back cover).

COMPONENTS ON COLOR LCD MONITOR SCREEN

Monitor screen

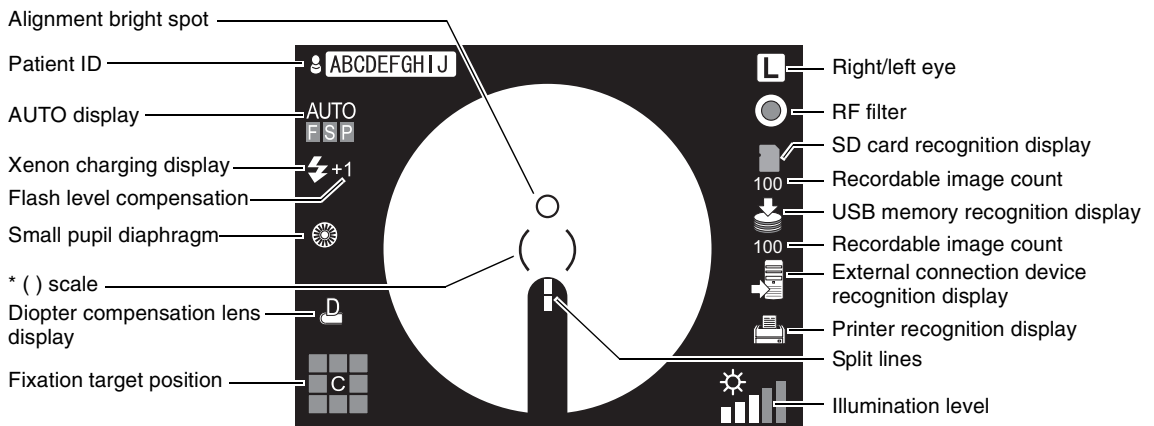

* When the () scale blinks in red, pull the base toward you (the operator) to the limit. For moving the instrument, refer to page 42.



The AUTO display shows the auto function that is ON. For setting the auto functions, refer to "MENU SETTING" on page 25.



"F" is lit: The auto focus function is ON. (Set it to "OFF", and "F" is darkened.)

"S" is lit: The auto shoot function is ON. (Set it to "OFF", and "S" is darkened.)

"P" is lit: The auto small pupil selector function is ON. (Set it to "OFF", and "P" is darkened.)



When the auto function, which has been set to "ON", is invalidated, a red oblique line is displayed.

The left figure shows that the auto small pupil selector function is invalidated.



The upper limit of the displayed recordable image quantity is "999".

MENU screen

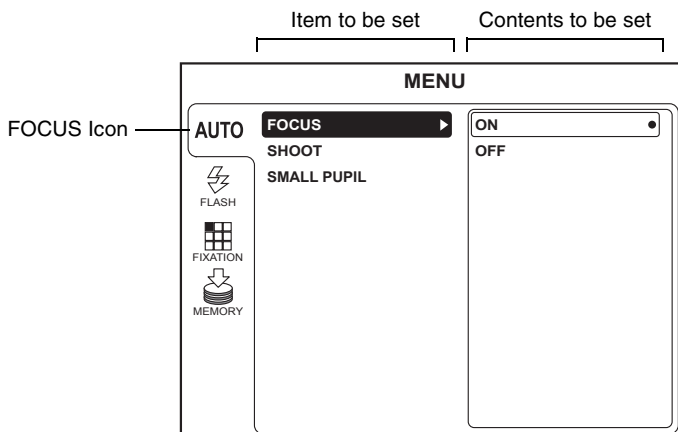

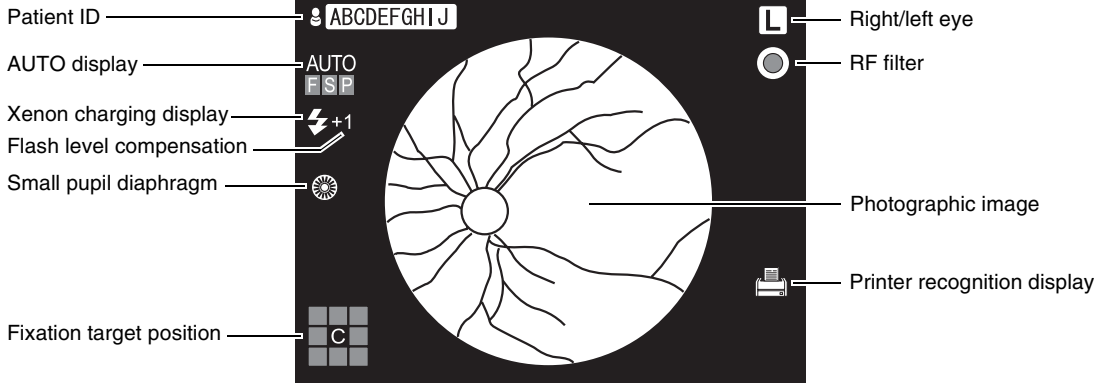

Preview screen





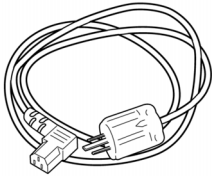
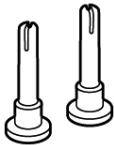
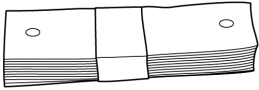
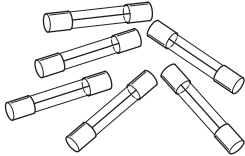

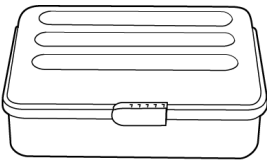
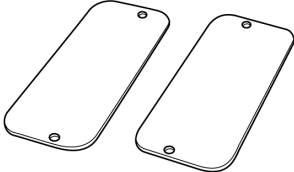
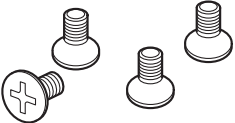
STANDARD ACCESSORIES

Upon unpacking, make sure that all the following standard accessories are included. Numbers in () are the quantities.

<p>Power cord (1)</p> 	<p>Chinrest tissue pin (2)</p> 
<p>Chinrest tissue paper (1)</p> 	<p>Fuse (6)</p> 
<p>Instruction manual (1)</p> 	<p>Dust cover (1)</p> 
<p>Spare parts case (1)</p> 	<p>Rail cover (2)</p> 
<p>Screw (4)</p> 	

PREPARATIONS

ASSEMBLY PROCEDURE OF THE INSTRUMENT BODY

 CAUTION	Before transporting this instrument, secure the fixing knob on the bottom to prevent movements.
 CAUTION	This instrument should be carried by two persons. Carrying by one person may cause backache or injury. Holding at areas other than the bottom may also cause injury, as well as falling, thereby damaging the instrument.
 CAUTION	To prevent damage and injuries, do not install the instrument on an uneven, unsteady or sloping surface.
 CAUTION	To avoid electric shock, unplug the power cord from the outlet before assembling. Do not plug the power cord into the outlet before assembling the instrument.
NOTE	Since the upper part and lower part of the instrument body are merely connected to each other with the power cable, take them out together so they do not separate from each other.
NOTE	Always place the instrument in the center of the instrument table.

1 Take out the instrument body from the cardboard box and put it on the table.

 Before transporting, make sure that the back-and-forth and right-and-left movement of the base stops because of the fixing knob. If the base moves, turn the fixing knob to stop it.

 When carrying the instrument body, firmly hold it at the following specified positions.

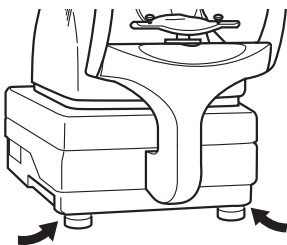

Holding positions

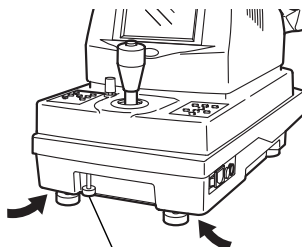

Fixing knob

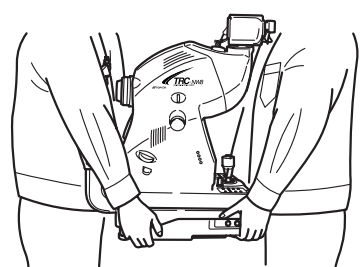

Holding the instrument body

2 Loosen the fixing knob.

- 3** Slightly raise the control lever and take out the cushion from the lower part of the base in the arrow direction.

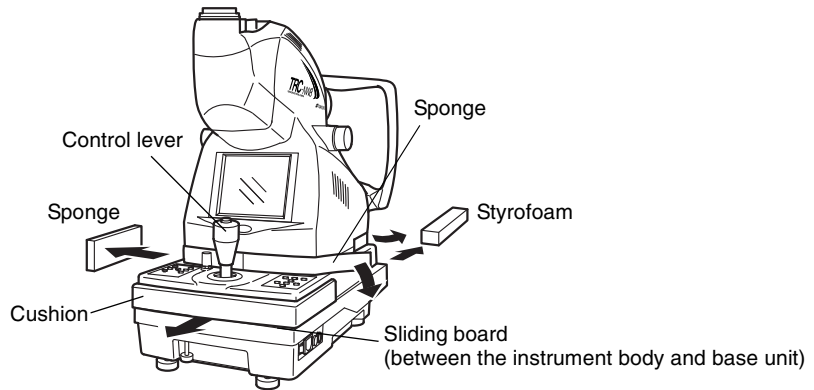

- 4** Wipe the sliding board with a cloth, etc. to remove dust.
- 5** Remove the styrofoam from the transportation bracket (A) (the one on the left hand side as viewed from the chinrest side), slide the base to the left and unscrew the transportation bracket (B).

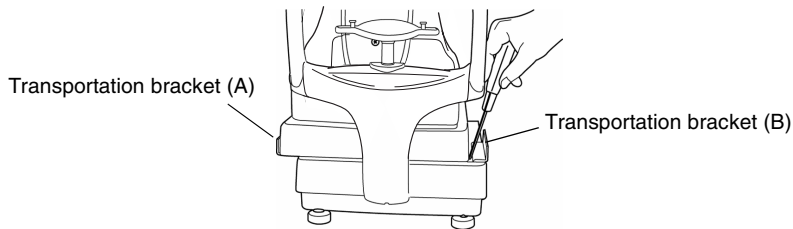

- 6** Slide the base to the right and unscrew the transportation bracket (A) with the screwdriver.
- 7** Fasten the rail covers, using the small screws that are attached.

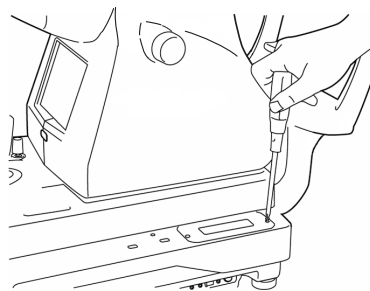

- 8** Affix the chinrest tissue paper with the chinrest tissue pin.

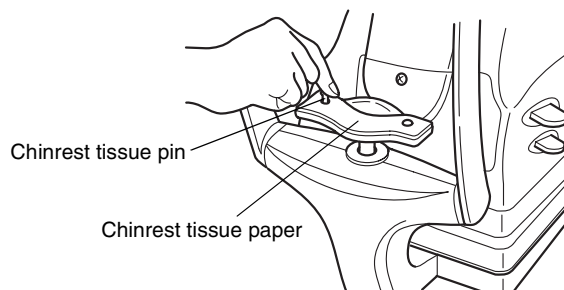

INSTALLING THE DIGITAL CAMERA

- 1** Remove the cap from the digital camera to be installed.
- 2** Align the positioning mark of the instrument with the mark on the digital camera's mount.

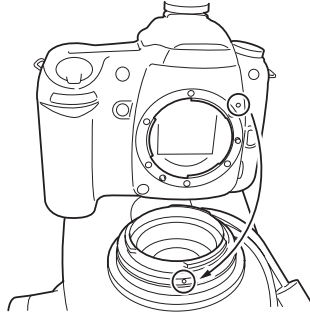

- 3** Turn the digital camera clockwise until a "click" is heard.

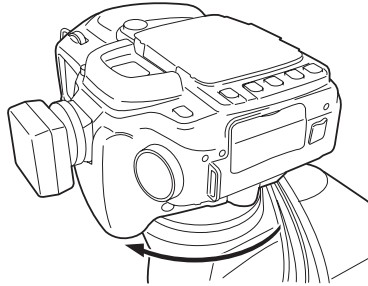

When taking out the digital camera from the instrument, turn the digital camera counter-clockwise while pressing its lens lock release button.



For some types of the digital cameras to be installed, a mount conversion adapter or tele converter is necessary.



Do not use a battery into the digital camera but use only the power supplied by the instrument.

HOW TO CONNECT THE CABLES

Connect the cables for the digital camera, which come out of the instrument.

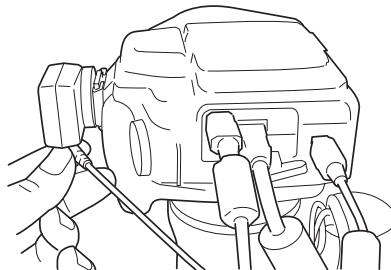

When connecting the cables, refer to the instruction manual of the digital camera.



If you have a question about the digital camera, contact your dealer or TOPCON (listed on the back cover).

CONFIRMATION AFTER ASSEMBLY

- 1** Make sure that the input voltage is within $\pm 10\%$ of the rated voltage for the instrument. If the input voltage exceeds this range, use a constant-voltage power supply (marketed: 400VA or more).
- 2** Loosen the base brake knob, and move the control lever to verify that it moves smoothly.
 - 1) Right-left movement
 - 2) Back-forth movement
 - 3) Up-down movement

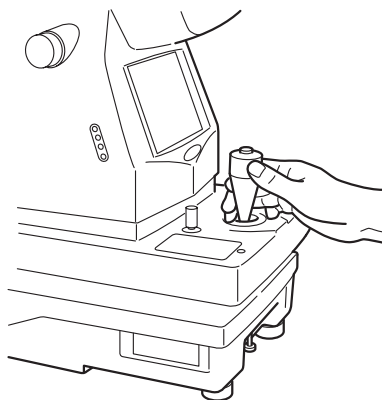

Just after being unpacked, the right-left movement may be uneven. If so, move the control lever with force to its limits in all directions.

- 3** If the instrument body is slightly off level, finely adjust the height by properly turning the four adjusters. Do not extend the adjusters past 1cm.

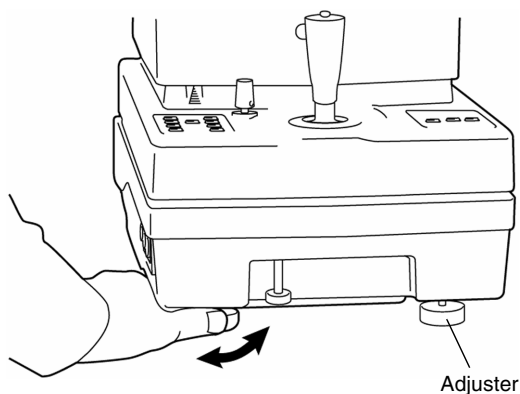

CONNECTING THE POWER CORD



WARNING

To avoid fire and electric shock in case of leakage, be sure to use a grounded outlet. Do not connect to outlets that are not grounded.



CAUTION

To avoid electric shock, do not handle the plugs with wet fingers.

- 1** Make sure that the **POWER SWITCH** of the instrument body is OFF (○).

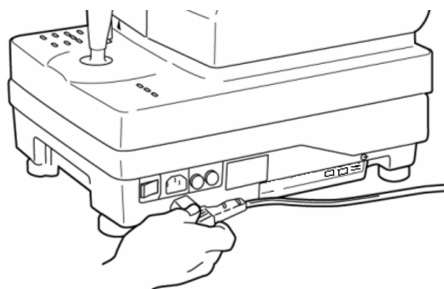

- 2** Attach the power cord to the instrument body.
- 3** Plug the power cord into a proper outlet with grounding.



Refrain from using UPS (Uninterruptible Power Supply). The trouble caused by using UPS will not be guaranteed.

CONNECTING THE EXTERNAL DEVICE

This instrument can be connected to an image filing system such as IMAGEnet (commercial product), etc.

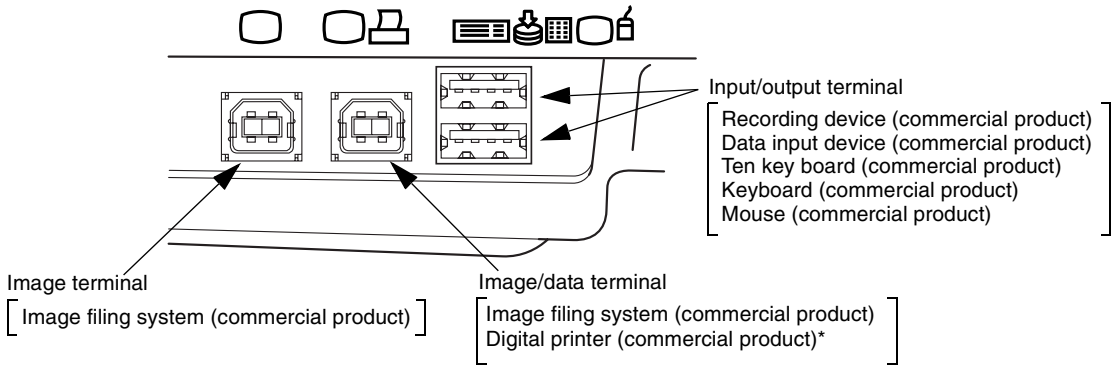

* By connecting the digital printer applicable to Pict Bridge, direct print is done.

Connecting to IMAGEnet (commercial product), etc.

1 Connect one USB cable (commercial product) to the image/data terminal .

 Be sure to connect IMAGEnet (commercial product), etc. to the image/data terminal.

2 Connect the other end of the USB cable to IMAGEnet, etc.

 Use the external device complying with IEC60950/IEC60950-1 or UL60950/UL60950-1.

 When the external device has the power save function, invalidate it. If not, the device may not operate normally.

 For details about connecting the external devices, contact your dealer or TOPCON (see the back cover).

 To increase the image transfer speed, connect IMAGEnet, etc. with two USB cables (commercial products). In this case, the photographed image is not displayed on the color LCD monitor. For details, contact your dealer or TOPCON (see the back cover).

 When connecting the external device, do not take a picture before the recognition displays shown below appear on the color LCD monitor.

Personal computer:  USB memory:  SD card:  Printer: 

 When you want to change the date stored in the recording device, contact your dealer or TOPCON office (see the back cover).

 Before using the USB memory, etc., make sure that it is not infected with the computer virus. Then, connect it.

 For the use of an image filing system such as IMAGEnet, etc., refer to the instruction manual of each system.



For the usable Pict Bridge printer, contact your dealer or TOPCON (see the back cover).



It is recommended to store the photographed image, which will be printed, into the USB memory, etc.



When connecting to the keyboard, do not use the keys which are not related to ID input. The window of the OS (Operating System) built in the instrument may be displayed. If this phenomenon occurs, turn off the instrument and turn it on again.

MENU SETTING

In menu setting, ON/OFF of the auto functions, the flash level and the fixation target can be set.

Preparations for menu setting

- 1** Check the power cord connections.
For details about the connection, see "CONNECTING THE POWER CORD" on page 22.
- 2** Turn the **POWER SWITCH** ON (I).

Displaying the menu screen

- 1** Make sure that the Monitor screen is displayed.
- 2** Press the **MENU SWITCH** on the control panel.
Make sure that "MENU" is displayed.

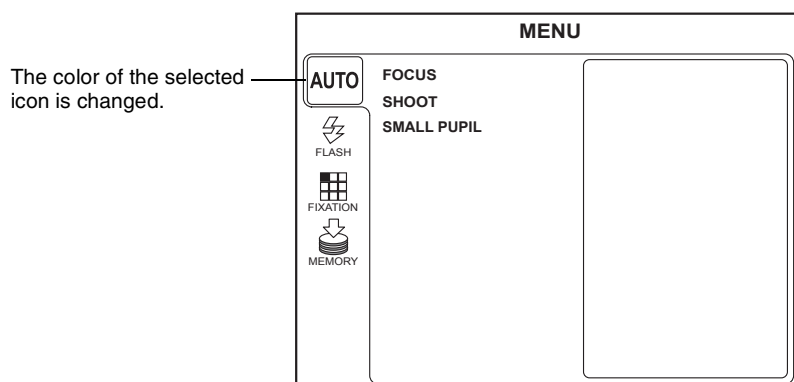

- 3** Press the **DOWNWARD CURSOR SWITCH** or **UPWARD CURSOR SWITCH**; the selected item is changed.
- 4** Press the **ENTER SWITCH**, and the selected item is chose.

Returning to the Monitor screen

- 1** Press the **MENU SWITCH**.

Setting of auto focus function

Set the auto focus function ON/OFF. (When shipped, "ON" is set.)

When auto focus is set to ON, focusing is automatically done when taking a picture.

- 1 On the "MENU" screen, make sure that "AUTO" is selected and press the **ENTER SWITCH**.
- 2 Press the **DOWNWARD CURSOR SWITCH** or **UPWARD CURSOR SWITCH** to select "FOCUS" and then press the **ENTER SWITCH**.

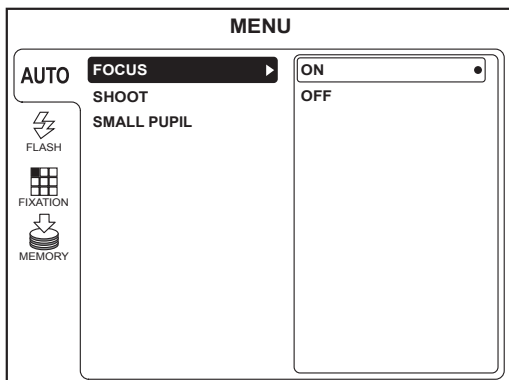

- 3 Select "ON" or "OFF" with the **DOWNWARD CURSOR SWITCH** or **UPWARD CURSOR SWITCH** and then press the **ENTER SWITCH**. The selected data is set.

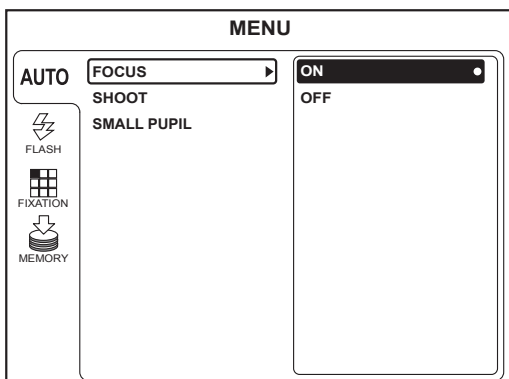

Setting of auto shoot function

Set the auto shoot function ON/OFF. (When shipped, "ON" is set.)

The auto shoot function works as follows: when the fitted alignment bright spot is put into () in the focalized status, the instrument takes a picture automatically without pressing the **PHOTOGRAPHY SWITCH**.

- 1 On the "MENU" screen, make sure that "AUTO" is selected and press the **ENTER SWITCH**.
- 2 Press the **DOWNWARD CURSOR SWITCH** or **UPWARD CURSOR SWITCH** to select "SHOOT" and then press the **ENTER SWITCH**.

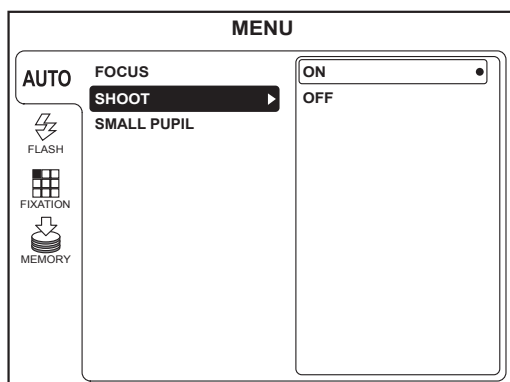

- 3 Select "ON" or "OFF" with the **DOWNWARD CURSOR SWITCH** or **UPWARD CURSOR SWITCH** and then press the **ENTER SWITCH**. The selected data is set.

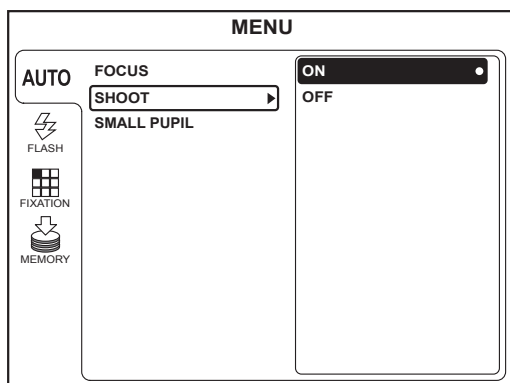

Setting of auto small pupil selector function

Set the auto small pupil selector function ON/OFF. (When shipped, "ON" is set.)

The auto small pupil selector function works as follows: when the pupil diameter of the patient is too small to take a picture, the instrument automatically changes to the small pupil diaphragm.

- 1 On the "MENU" screen, make sure that "AUTO" is selected and press the **ENTER SWITCH**.
- 2 Press the **DOWNWARD CURSOR SWITCH** or **UPWARD CURSOR SWITCH** to select "SMALL PUPIL" and then press the **ENTER SWITCH**.

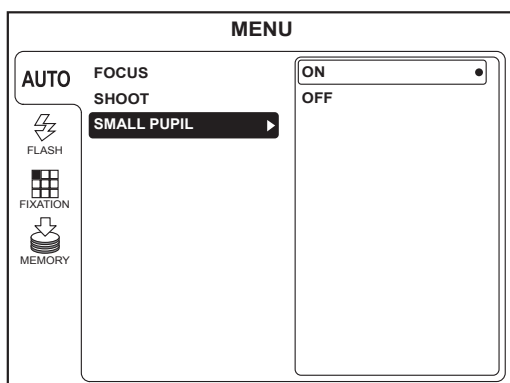

- 3 Select "ON" or "OFF" with the **DOWNWARD CURSOR SWITCH** or **UPWARD CURSOR SWITCH** and then press the **ENTER SWITCH**. The selected data is set.

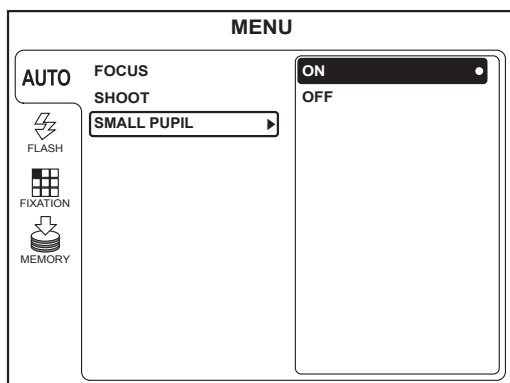

Switching of internal/external fixation targets (The external fixation target is an optional accessory.)

You can change the internal/external fixation targets.

When shipped, "INTERNAL" (internal fixation target) is set.

- 1 Select "FIXATION" on the "MENU" screen and press the **ENTER SWITCH**.

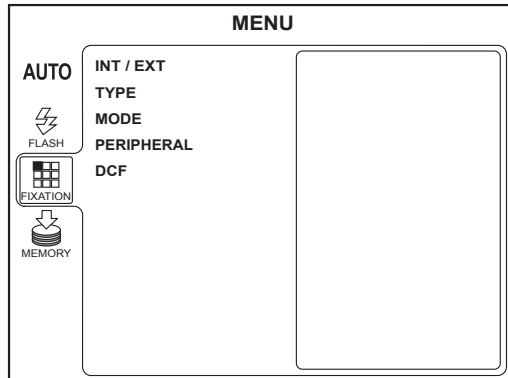

- 2 Press the **DOWNWARD CURSOR SWITCH** or **UPWARD CURSOR SWITCH** to select "INT/EXT" and then press the **ENTER SWITCH**.

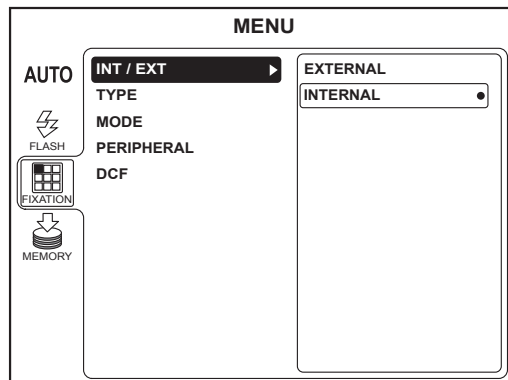

- 3 Press the **DOWNWARD CURSOR SWITCH** or **UPWARD CURSOR SWITCH** to select "INTERNAL" (internal fixation target) or "EXTERNAL" (external fixation target). Then, press the **ENTER SWITCH**.

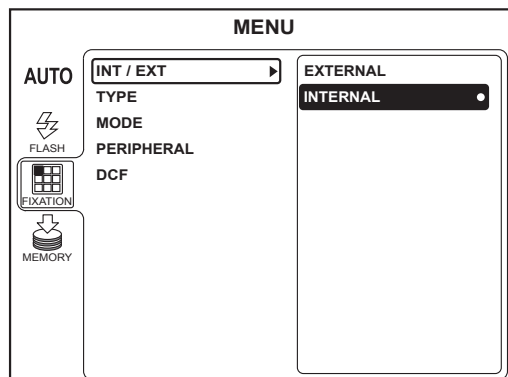

Fixation target pattern

You can select the fixation target pattern.
When shipped, "8POINT" is set.

- 1 Move the cursor to "FIXATION" on the "MENU" screen, and press the **ENTER SWITCH**.

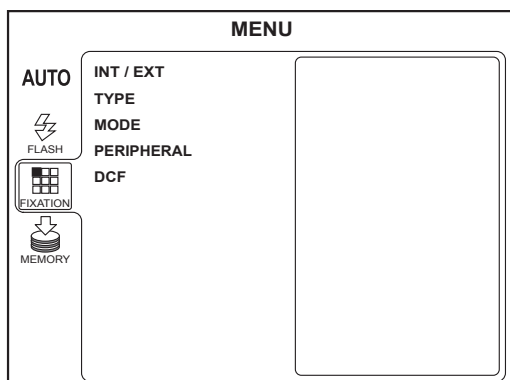

- 2 Press the **DOWNWARD CURSOR SWITCH** or **UPWARD CURSOR SWITCH** to select "PERIPHERAL" and then press the **ENTER SWITCH**.

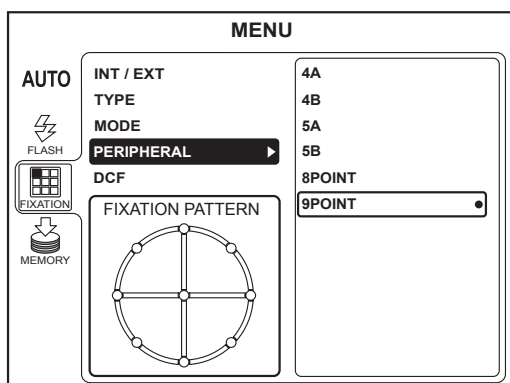

- 3 Press the **DOWNWARD CURSOR SWITCH** or **UPWARD CURSOR SWITCH** and select the desired pattern from the following:

"4A" (diagonal 4 positions),
"4B" (vertical-horizontal 4 positions),
"5A" (diagonal 4 positions + center),
"5B" (vertical-horizontal 4 positions + center),
"8POINT" (8 positions), or
"9POINT" (8 positions + center).
Press the **ENTER SWITCH**.

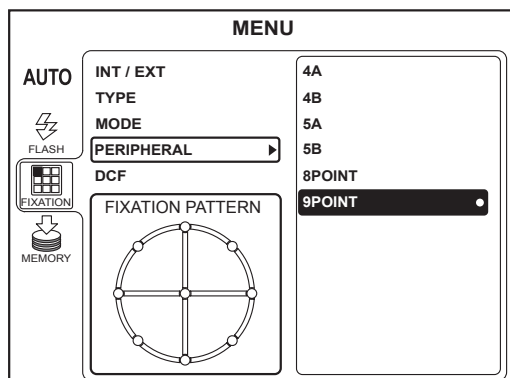

For setting and lighting the internal fixation target, refer to "MEMO" on page 49.

SETTING THE RECORDING MEDIUM TO SAVE IMAGE

Set the recording medium to save the photographed image.

When saving the image in the USB memory (commercial product), etc.

It is not necessary to set some items on "MENU". Connect the recording device such as the USB memory (hereinafter, USB memory) to the input/output terminal. The instrument automatically recognizes the USB memory and the USB recognition mark is displayed on the color LCD monitor. The photographed image will be saved in the USB memory. When disconnecting the USB memory, follow the procedure shown below.

- 1** Select "MEMORY" on the "MENU" screen and press the **ENTER SWITCH**.

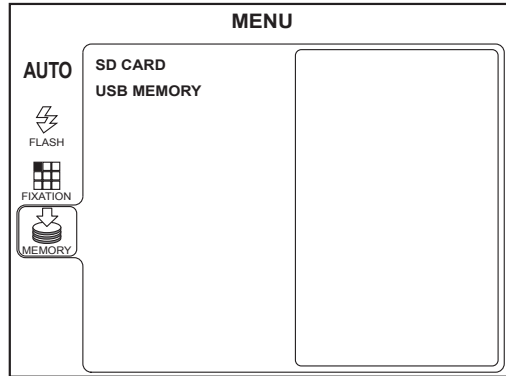

- 2** Press the **UPWARD CURSOR SWITCH** or **DOWNWARD CURSOR SWITCH** to select "USB MEMORY". Then, press the **ENTER SWITCH**.

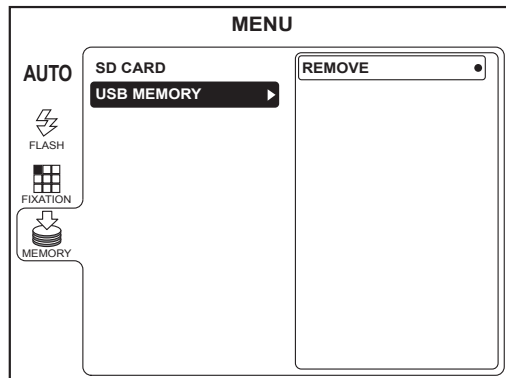

- 3** Make sure that "REMOVE" is selected and then press the **ENTER SWITCH**.

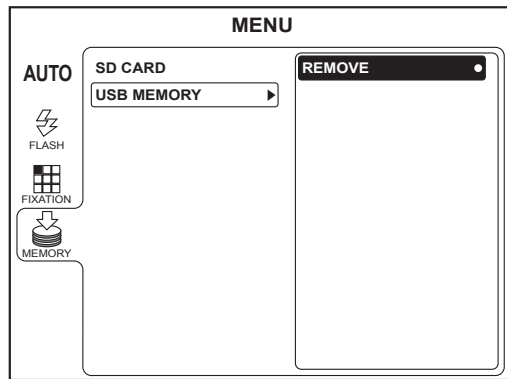

- 4** When the message "THE MEMORY CAN BE REMOVED." is displayed on the color LCD monitor, disconnect the USB memory from the input/output terminal.



If the message "THE MEMORY CAN NOT BE STOPPED. PLEASE TRY AGAIN." is displayed, wait for a while and repeat the procedure from Step 1 again.



If you wait for a while but the USB memory recognition icon is not displayed, disconnect and connect the USB memory.



Before using the USB memory, it is recommended to format it with a personal computer.

When saving in the SD memory card (commercial product)

When you insert the SD memory card (hereinafter, SD card) into the installed digital camera and want to save the photographed image in the SD card, set the items according to the following procedure.

- 1 Select "MEMORY" on the "MENU" screen and press the **ENTER SWITCH**.

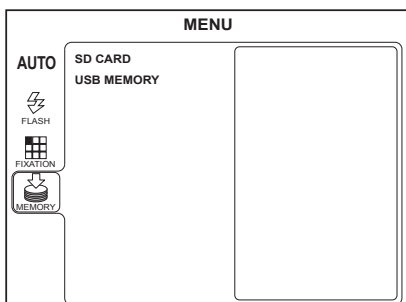

- 2 Press the **UPWARD CURSOR SWITCH** or **DOWNWARD CURSOR SWITCH** to select "SD CARD". Then, press the **ENTER SWITCH**.

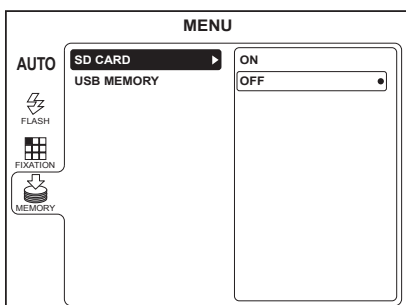

- 3 Press the **UPWARD CURSOR SWITCH** or **DOWNWARD CURSOR SWITCH** to select "ON". Then, press the **ENTER SWITCH**.

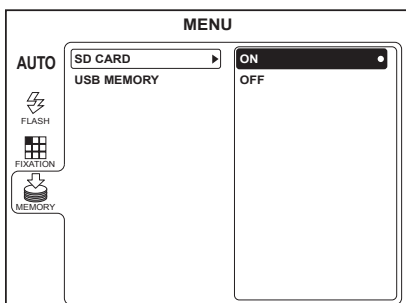

In some type of the digital camera to be installed, the SD card cannot be used.



As more images are recorded on the SD card, it takes longer to display the Monitor screen after the instrument is turned on.



When you exchange digital camera, please exchange SD card at the same time.



Before installing or removing the SD card, make sure that the power of the digital camera is OFF.

Menu functions list

You can also change the set data for other items in the same way as setting of the auto functions. The settable menus are shown below.

Setting of the AUTO functions (AUTO)

Item	Contents	Initial setting	Explanation
FOCUS	ON/OFF	ON	Select ON/OFF of auto focus function.
SHOOT	ON/OFF	ON	Select ON/OFF of auto shoot function.
SMALL PUPIL	ON/OFF	ON	Select ON/OFF of auto small pupil selector function.

Setting of the flash level (FLASH)

Item	Contents	Initial setting	Explanation
FLASH MODE	NORMAL LOW1/2 LOW1/4	NORMAL	When selecting "LOW1/2" and "LOW1/4", the "low invasive mode" is accessed. The flash level is changed to "1/2" and "1/4" of the reference value and the ISO sensitivity of the digital camera, to "x2" and "x4".
COLOR BASE LVL	-4 to +4	0	Set the reference value of flash level (in color photography). When you set "0", the reference value of flash level is 7.9W.s.
GREEN BASE LVL	-4 to +4	0	Set the reference value of flash level (in red-free photography). When you set "0", the reference value of flash level is 22W.s.

Setting of the internal fixation target (FIXATION)

Item	Contents	Initial setting	Explanation
INT/EXT	INTERNAL EXTERNAL	INTERNAL	Select the internal or external fixation target.
TYPE	PERIPHERAL DCF	PERIPHERAL	When using the internal fixation target, select whether it should be used as the peripheral fixation target or DCF.
* MODE	DEFAULT CUSTOM	DEFAULT	To light up the LED when using DCF, select "Default setting" or "Custom setting".
PERIPHERAL	4A/4B/5A/5B /8POINT /9POINT	8POINT	Select the peripheral fixation target pattern. 4A (diagonal 4 positions) 4B (vertical-horizontal 4 positions) 5A (diagonal 4 positions + center) 5B (vertical-horizontal 4 positions + center) 8POINT (8 positions) 9POINT (8 positions + center)
DCF	P2/P3	P2	Select the DCF pattern. P2 (C: center, D: center of optic disc) P3 (C: center, D: center of optic disc, F: center of macula)

* When "DEFAULT" is set, "Center", "Center of optic disc" or "Center of macula" is lit in the DCF mode. For details, refer to page 49. When "CUSTOM" is set, the optional point is lit in the DCF mode. But, when shipped, the instrument is set so that the same point as "DEFAULT" may be lit. When you want to change the lighting point for "CUSTOM", contact your dealer or TOPCON office (see the back cover).

Setting of the recording medium to save image (MEMORY)

Item	Contents	Initial setting	Explanation
SD CARD	ON OFF	OFF	Select "ON" to save the photographed image in SD CARD. Select "OFF" not to save the photographed image in it.
USB MEMORY	REMOVE	—	Select "REMOVE" to remove the USB memory from the instrument.

RESET FROM POWER SAVE STATE

This machine adopts the power save method for power saving.

When the instrument body is not operated within a set time, the power save function stops power supply to the monitor, CCD camera, illumination light source and photography light source.

When power save sets in, the power lamp on the control panel flickers and the monitor screen goes off.

1 Press the .

The color LCD monitor is displayed and ready for photography.



When shipped, the power save set time is 10 minutes.

To change the set time, contact your dealer or TOPCON (see the back cover).

BASIC OPERATIONS

FLOW OF OPERATION

Photography procedure explained in "COLOR PHOTOGRAPHY (CENTER)"

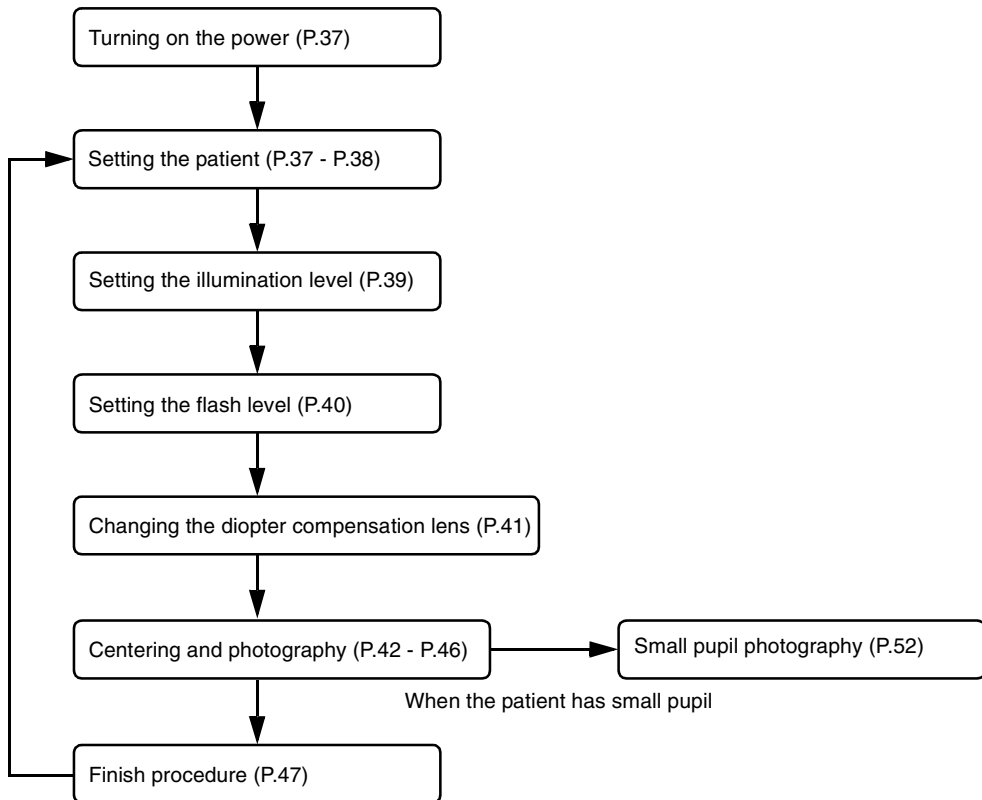

OTHER TYPES OF PHOTOGRAPHY

- Peripheral photography (P.48)
- Red-free photography with RF filter (P.55)
- Anterior segment photography (P.56 - P.57)
- Stereo photography (P.58 - P.59)

PREPARATION FOR PHOTOGRAPHY

Applying the power supply

- 1** Carefully check the power cord connection.
For details about the connection, see "CONNECTING THE POWER CORD" on page 22.
- 2** Turn on any external connection device.
- 3** Turn ON (|) the **POWER SWITCH** of the instrument.
- 4** Make sure that the title screen and the Monitor screen are displayed.



Right after the power is turned on, nothing is displayed for a while. This is not the trouble in the instrument. Wait until the title screen appears.

Patient setting

! CAUTION	To avoid injury to the patient's face and hands, be sure to operate the chinrest for height adjustment while directly watching the patient.
NOTE	If the patient wears glasses or contact lenses, remove them first.
NOTE	To ensure correct imaging, adjust the table height so the patient has his/her chin placed centrally on the chinrest.

- 1** Make sure the main Monitor screen is on.
- 2** Press the **ID INPUT SWITCH**, and the ID number input screen appears.

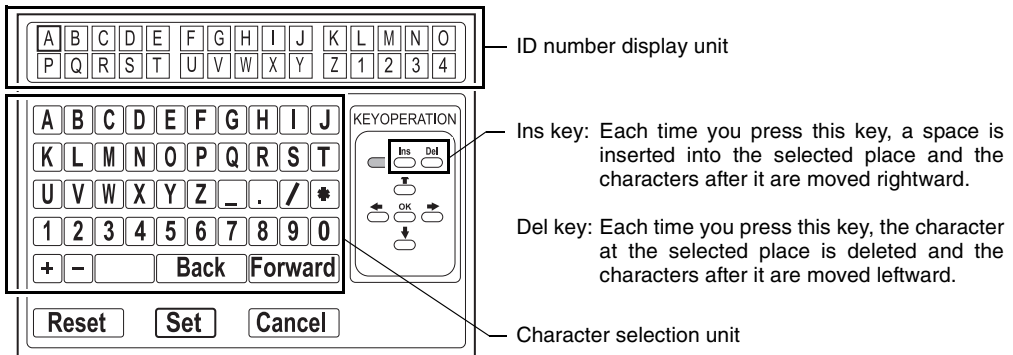

- 3** Move to the character to be inputted with the cursor switches of the instrument.
- 4** Press the **ENTER SWITCH** of the instrument to select the character.



The cursor character in the ID number display unit is changed to the selected character. Then, the cursor moves rightward. To move the cursor in the ID number display unit leftward, select "Back" in the character selection unit. To move it rightward, select "Forward".

- 5** Repeat Step 3 - 4 to input all the digits.



Connect the mouse to the input/output terminal, and the mouse pointer is displayed only when inputting ID. Fit the mouse pointer to a desired character and click the left button of the mouse. The cursor character in the ID number display unit is changed to the selected character. Then, the cursor moves rightward.

6 Select "Set". The inputted ID is validated and the system exists from the input screen



If you press the **ID INPUT SWITCH** again, the inputted ID is canceled.



It is possible to take a picture even if the ID is not inputted.

7 Make sure that the IR filter selector is on.

IR filter selector being pushed in

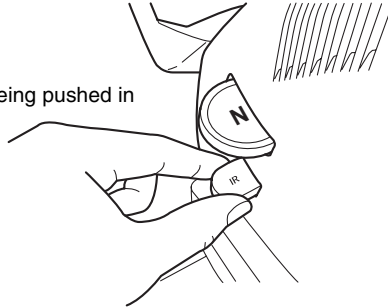

8 Seat patient comfortably.

9 Adjust the table height or chair height so the patient has his/her chin placed centrally on the chinrest.

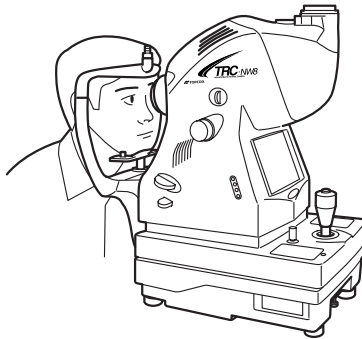

10 Adjust the chinrest height with the **CHINREST SWITCH** so the outside corner of the patient's eye is level with the Canthus marker on the chinrest post.

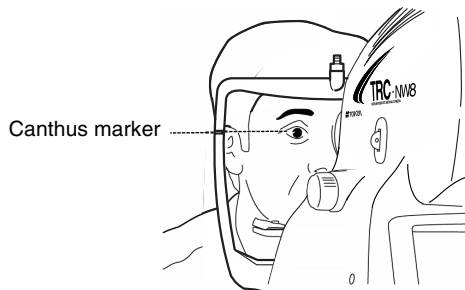

The chinrest moves up/down while the **CHINREST SWITCH** is pressed.
If the chinrest does not move though you press the **CHINREST SWITCH**, it malfunctions.
Set the **POWER SWITCH** to the OFF (○) side and unplug the power cord from the outlet.
Then, contact your dealer or TOPCON (see the back cover).

COLOR PHOTOGRAPHY (CENTER)

Setting the illumination level

CAUTION

To avoid pain and discomfort to the patient and damage to the patient's eye, do not brighten the illumination lamp more than necessary.

Set the illumination level using the **ILLUMINATION LEVEL SWITCH**.

You can verify the current level using the illumination level display on the color LCD monitor.

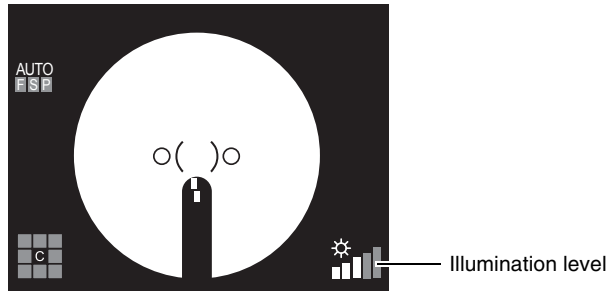
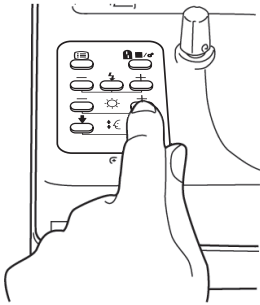

Normally the illumination level has five steps.

When the instrument is first turned on, the illumination level is set to level 3.

Setting the flash level



CAUTION

To avoid pain and discomfort to the patient and damage to the patient's eye, do not brighten the photography light more than necessary.

Set the flash level using the **FLASH LEVEL SWITCH**.

The compensation value can be checked with the flash level compensation display on the color LCD monitor.

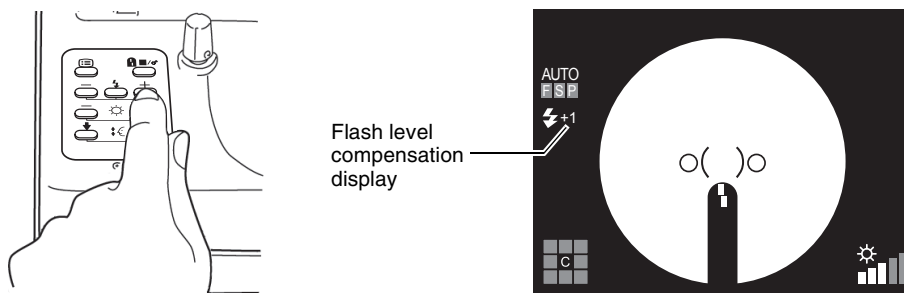

The flash level can be compensated in four steps in both the (+) and (-) directions from the reference value.

When the flash level is the reference value, no compensation value is displayed.

When the instrument is first turned on, the flash level is set to the reference value.



You can adjust the reference value of the flash level in four steps in both (+) and (-) directions.



The flash level display can also display the light intensity level (unit: W·s) in addition to the compensation value.

For details about the flash level setting, contact your dealer or TOPCON (see the back cover).



When the flash level compensation display is changed to the higher level by one step, the flash level is increased by approx. 20%.

Changing the diopter compensation lens

Pull out the diopter compensation lens selector and change the diopter compensation lens for the patient's eye.

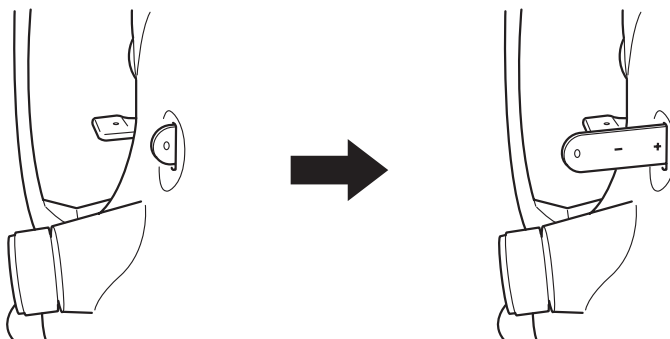

On a highly myopic patient, pull out the diopter compensation lens selector by one step and set it to (-) myopia.

On a highly hyperopic patient, pull out the diopter compensation lens selector by two steps and set it to (+) hyperopia.

Compensation range: 0 : -13 to +12D
- : -33 to -12D
+ : +9 to +40D





When the diopter compensation lens is set to any other value except "0", the split lines disappear.



When the diopter compensation lens is inserted, its indication blinks at the lower left corner on the Monitor screen. At this time, the auto focus/auto shoot functions and auto small pupil selector function are disabled.

Centering and photography

 CAUTION	To avoid injury while moving the instrument, do not place your fingers into the gap between the instrument body and the power supply unit.
 CAUTION	To avoid injury to the patient's eyes and nose while moving the instrument body, keep a safe distance between the patient and the objective lens.

The centering operation is done with the control lever.



Centering the instrument body with the control lever

- Fine movements of the base, back and forth and right and left, are done by tilting the control lever.
Before performing this operation, free the base by turning the base brake knob to the left.
To lock the base, turn the base brake knob right.

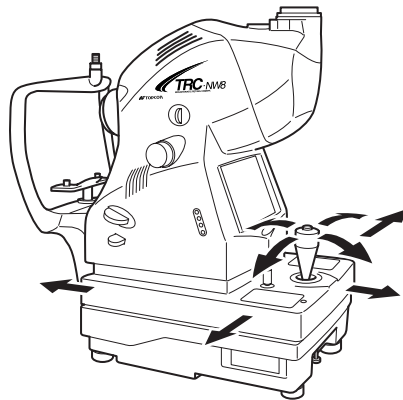

Operating the control lever
(in all directions)

- To move the instrument body up/down, turn the control lever right for upward movement, and left for downward movement.
The vertical position of the instrument body can be checked with the vertical position mark.

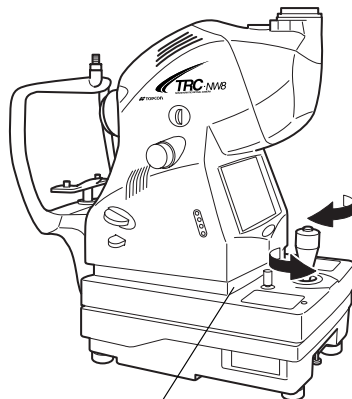

Vertical position mark

Operating the control lever
(in a vertical direction)

- 1** Hold the control lever and pull the instrument backwards toward the operator. As the internal fixation target flickers, instruct the patient to look at the fixation target in the center. Observe the anterior segment image on the color LCD monitor.
- 2** Move the instrument body using the control lever until you get the patient's eye centered in the color LCD monitor.

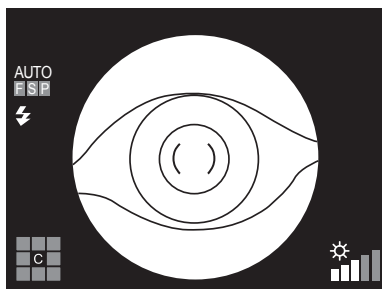

Hold the control lever perpendicularly, which facilitates centering on the fundus.

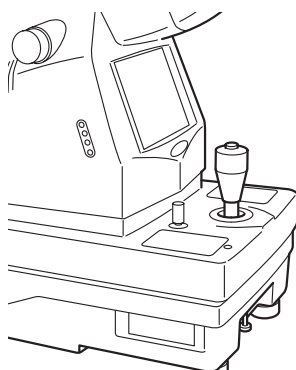

- 3** On the color LCD monitor, bring the () scale towards the patient's pupil, and make sure that the pupil is larger than the () scale.



Comparison of the () scale and the pupil tells you whether the pupil is large enough for retinal photography.

The following pictures are provided as a reference.

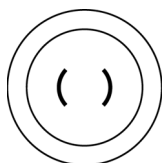

Well dilated.

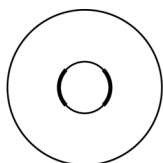

Narrowly dilated for photography.

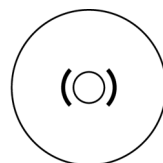

Pupil diameter is too small: darken the room and further dilate the pupil. If the pupil diameter is still smaller than the () scale, use the small pupil mode (P.52).

- 4** Slowly bring the instrument closer to the patient; the retina image will appear on the color LCD monitor.

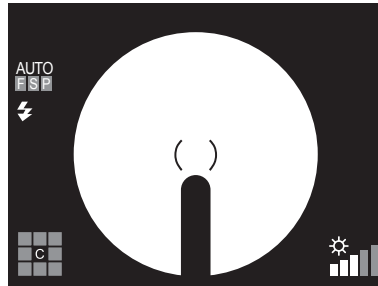

- 5** Instruct the patient to look at the green light (internal fixation target).

- 6** While watching the image on the color LCD monitor, adjust the brightness of the image using the **ILLUMINATION LEVEL SWITCH**.



For details about the illumination level setting, see page 39.

- 7** Bring the instrument even closer to the patient; and two bright spots for the working distance alignment become visible.

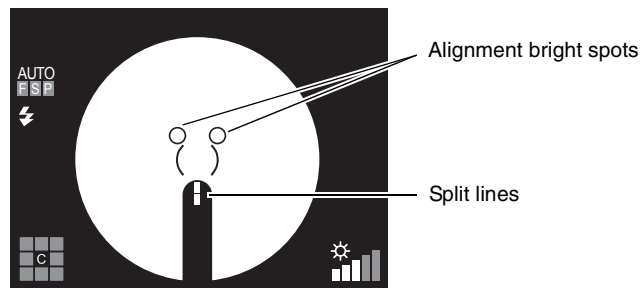

When the auto focus function is ON, the instrument changes the split lines into one line. At this time, the fundus is almost in focus.

The auto focus function does not work for ocular pathology (e.g. strong cataract), myopia and hyperopia (beyond -13 to +12D), etc. from time to time.



When the auto focus function is OFF, operate the focusing knob to change the split lines into one line on the color LCD monitor.

- 8** Operate the control lever until the two alignment bright spots are changed to one spot.

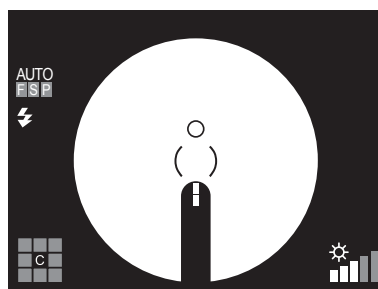



When the patient's eye is beyond -13 to +12D, the instruction to insert the diopter compensation lens appears on the color LCD monitor screen. At this time, change the diopter compensation lens. Refer to "Changing the diopter compensation lens" on page 41.

Since the split lines are off when the diopter compensation lens is anything other than (0), turn the focusing knob so that the fundus image is clearly visible on the color LCD monitor.

At the same time all the automatic functions are invalidated.

- Operate the control lever and move the instrument body to bring the bright spot of the color LCD monitor into the () scale.

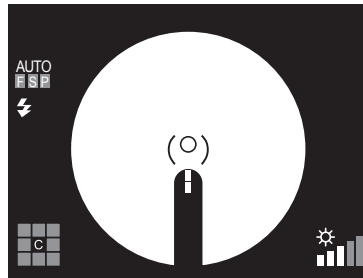

- When the positional relation between the instrument body and the patient's eye is proper for photography, the instrument automatically takes a picture.



When the auto shoot function is OFF, the instrument does not take a picture automatically. Check the bright spot on the color LCD monitor and press the **PHOTOGRAPHY SWITCH** to take a picture.



Use the **AUTO SWITCH** to turn ON/OFF all the auto functions, which have been set to "ON" in "MENU", at the same time. Press the **AUTO SWITCH** to turn OFF the auto functions, and the AUTO display disappears on the color LCD monitor.



If the split lines cannot be seen, check if dilation is sufficient or if the eye is obstructed by eyelashes or the eyelid, interrupting the light.



You can remove the split lines from the Monitor screen if they are not necessary.

Press the **SPLIT SWITCH** to remove the split lines from the Monitor screen.

Press the **SPLIT SWITCH** again to display the split lines on the Monitor screen.

When the split lines are erased on the Monitor screen, the auto focus/auto shoot functions and auto small pupil selector function do not work.



If the patient blinks when taking a picture, the blink detection function works to stop photography.



When the xenon charging display flickers on the color LCD monitor, photography is not possible even by pressing the **PHOTOGRAPHY SWITCH**.

Wait until the xenon charging display turns on before you attempt to take the next image.

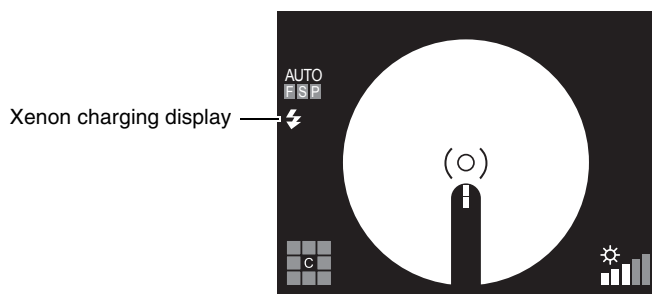

- 11** The captured image is stored in the external recording device and displayed on the color LCD monitor.

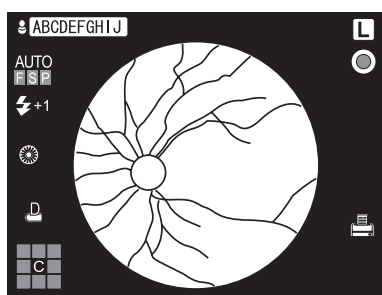

If the light intensity of the image is insufficient, compensate for it by pressing the **FLASH LEVEL SWITCH**, and repeat the centering and photography procedure.



When connecting to IMAGEnet (commercial product), etc. with two USB cables, the pre-view screen is not indicated.

- 12** To return to the Monitor screen from the photographed image on the color LCD monitor, press the **PHOTOGRAPHY SWITCH** again.



When a digital printer is connected to the instrument, the image is printed by pressing the **PHOTOGRAPHY SWITCH**. To return to the Monitor screen without printing, press the **IMAGE DELETION SWITCH**.

EXITING

- 1** Turn OFF(O) the **POWER SWITCH** on the instrument body and the external recording device.
- 2** While operating the control lever, move the instrument body so that it comes just above the base.
- 3** To prevent the base from moving suddenly, turn the base brake knob to the right to lock the base.



For the next capture, turn the control lever and move the body to the center position. The vertical center position of the instrument can be checked with the vertical position mark.



When you are not going to use the instrument for a long period of time, remove the power cords of the instrument body and external recording device from the power outlets, and remove all cords connecting the instrument to the external capture device.



This instrument adopts the power save method (P.35). If you are going to use the instrument after a short pause period, it is recommended to use it without turning off the **POWER SWITCH**.



To keep the cleanliness of the instrument, before taking a picture of the next patient, remove the chinrest tissue at the top and clean the forehead rest and chinrest. See page 80.

OBJECTIVE OPERATIONS

PERIPHERAL PHOTOGRAPHY

Setting the picture position

- When the fixation target mode is set at "PERIPHERAL" (When shipped, "PERIPHERAL" is set.):
To set the periphery, use the **FIXATION TARGET SELECTOR SWITCH**.

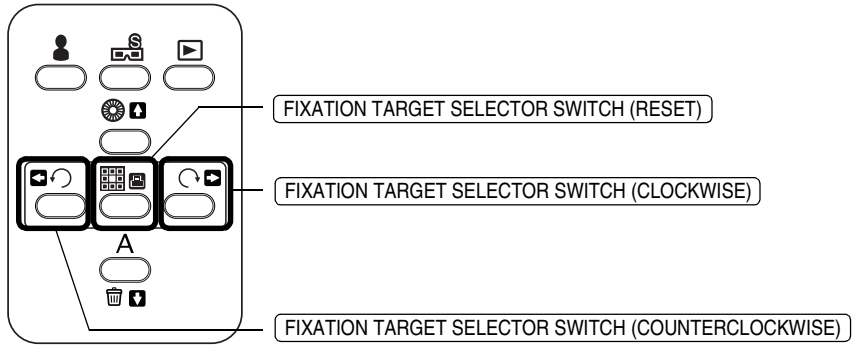

Press the **FIXATION TARGET SELECTOR SWITCH (COUNTERCLOCKWISE)**, and the peripheral photography mode is accessed. Each time you press the **FIXATION TARGET SELECTOR SWITCH (COUNTERCLOCKWISE)**, the fixation position moves one by one in the order (numerical order) of Fig. A.

Press the **FIXATION TARGET SELECTOR SWITCH (CLOCKWISE)** at any position except the center position. The position moves reversely (reversed order).

Press the **FIXATION TARGET SELECTOR SWITCH (CLOCKWISE)** at the center position. The position moves in the order (numerical order) of Fig. B.

Press the **FIXATION TARGET SELECTOR SWITCH (CLOCKWISE)**, and the peripheral photography mode is accessed. Each time you press the **FIXATION TARGET SELECTOR SWITCH (CLOCKWISE)**, the fixation position moves one by one in the order (numerical order) of Fig. B.

Press the **FIXATION TARGET SELECTOR SWITCH (COUNTERCLOCKWISE)** at any position except the center position. The position moves reversely (reversed order).

Press the **FIXATION TARGET SELECTOR SWITCH (COUNTERCLOCKWISE)** at the center position. The position moves in the order (numerical order) of Fig. A.

Press the **FIXATION TARGET SELECTOR SWITCH (RESET)**, and the fixation is reset at the normal position (not the optical axis center).

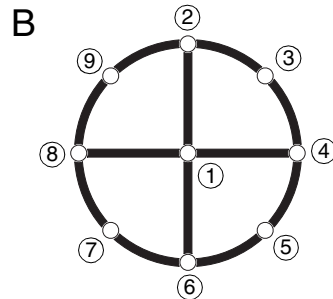
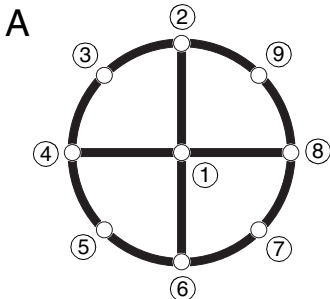

Number of frame is shown in the fixation display position.



The ① position shown above is assigned to the optical axis center and is used for photographing around the macula segment.



The following figure and table show the fixation target pattern and the internal fixation lighting point corresponding to it.

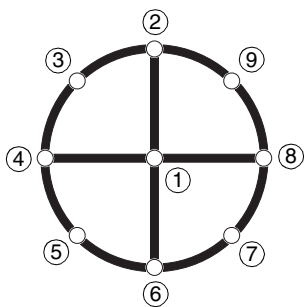

Fixation target pattern	Lighting point
4A	③ ⑤ ⑦ ⑨
4B	② ④ ⑥ ⑧
5A	① ③ ⑤ ⑦ ⑨
5B	① ② ④ ⑥ ⑧
8POINT	② ③ ④ ⑤ ⑥ ⑦ ⑧ ⑨
9POINT	① ② ③ ④ ⑤ ⑥ ⑦ ⑧ ⑨

For setting the fixation target pattern, refer to "Fixation target pattern" on page 30.



When you want to set the fixation target mode to "DCF", select "FIXATION" on the "MENU" screen and next "TYPE". Then, select "DCF".

- When the fixation target mode is set at "DCF":

To set the periphery, each time you press the **FIXATION TARGET SELECTOR SWITCH (CLOCKWISE)** or **FIXATION TARGET SELECTOR SWITCH (COUNTERCLOCKWISE)**, the setting changes from "D" (center of optic disc) to "C" (center) alternatively.



The above explains the case in which "P2" is set for "DCF". In addition to "P2", it is possible to set "P3" (D: center of optic disc, C: center, F: center of macula). To set it, select "FIXATION" on the "MENU" screen and next "DCF". Then, select "P3".

When "P3" is set, the setting changes in the following order: "C" (center) → "D" (center of optic disc) → "F" (center of macula).



Fixation position display (at right eye)



Fixation position display (at left eye)



Number of frame is shown in the fixation display position.

Centering and photography

The centering operation is done with the control lever.

For details about the movement/adjustment of the instrument body with the control lever, see the "MEMO" on page 42.

- 1 Hold the control lever and pull the instrument backwards toward the operator. As the anterior segment fixation target flickers, instruct the patient to look at the fixation target. Observe the anterior segment image on the color LCD monitor.

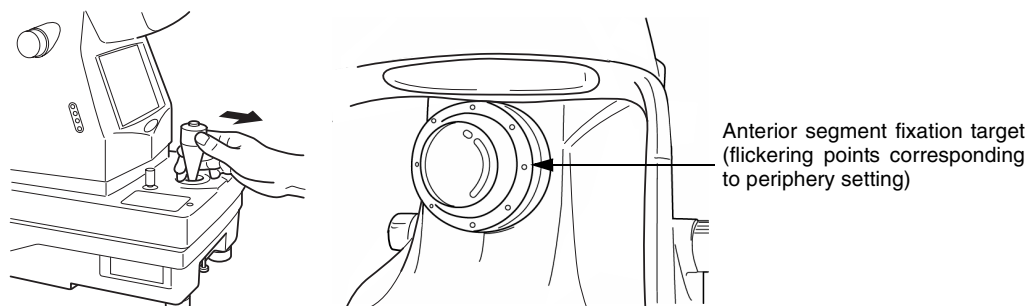

- 2 Using the control lever, move the instrument body in all directions to get the patient's eye in the center of the color LCD monitor.

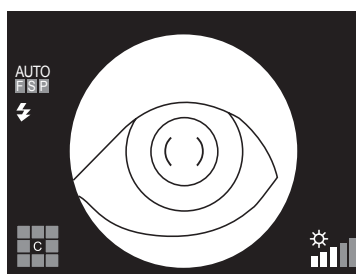

- 3 On the color LCD monitor, bring the () scale to the patient's pupil, and make sure that the pupil is larger than the () scale.



For details about dilation, see the "MEMO" on page 43.

- 4 Slowly bring the instrument closer to the patient; the fundus image appears on the color LCD monitor.

- 5 In this instance, the () scale on the color LCD monitor moves to an alignment position corresponding to the picture position. At the same time, the anterior segment fixation target is changed to the internal fixation target.

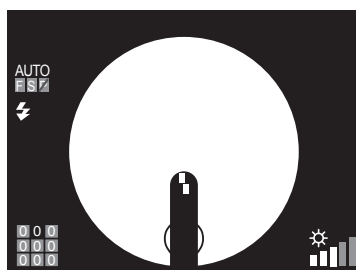

6 By operating the ILLUMINATION LEVEL SWITCH, adjust the brightness of the image while watching it on the color LCD monitor.



For details about the illumination level setting, see the "MEMO" on page 39.

7 For the steps to follow, see "Centering and photography" on page 42 for color photography.

SMALL PUPIL PHOTOGRAPHY

When the patient's pupil diameter is small, perform the small pupil photography. When the auto small pupil selector function is set to "ON", the small pupil diaphragm is automatically set. Take a picture in the same way as the procedure of "COLOR PHOTOGRAPHY (CENTER)" on page 39 and after. When the auto small pupil selector function is set to "OFF", take a picture by the following procedure. Even when the auto small pupil function is set to "ON", you can also take a picture by the following procedure.



For the patient's pupil condition, refer to "MEMO" on page 43. When you have judged before photographing that the pupil diameter is small or when the small pupil diaphragm mark blinks, it is recommended to take a picture by the following procedure.

- 1** Using the control lever, move the instrument body in all directions to get the patient's eye in the center of the color LCD monitor.

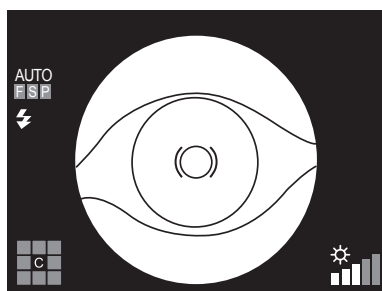

- 2** On the color LCD monitor, bring the () scale to the patient's pupil. If the patient's pupil is smaller than the () scale, press the **(ILLUMINATION DIAPHRAGM SELECTOR SWITCH)**.



On the color LCD monitor, the small pupil diaphragm mark is displayed.

- 3** Slowly bring the base unit closer to the patient; the fundus image appears on the color LCD monitor.

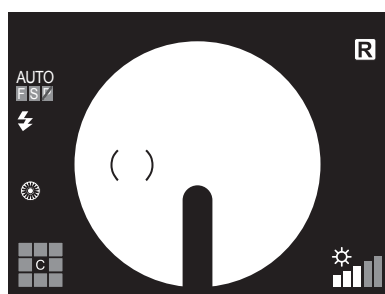

Right eye



Left eye





When the fixation target is in the center, the () scale is displayed at the left side for right eye, and at the right side for left eye.

- 4** Instruct the patient to look at the green light (internal fixation target).
- 5** By operating the **(ILLUMINATION LEVEL SWITCH)**, adjust the brightness of the image while watching it on the color LCD monitor.

 For details about the illumination level setting, see "Setting the illumination level" on page 39.

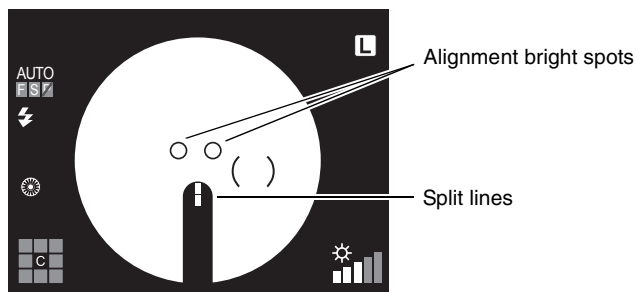
6 Bring the instrument even closer to the patient, and two bright spots for the working distance alignment become visible.



 When the auto focus function is ON, the instrument changes the split lines into one line. At this time, the fundus is almost in focus.

The auto focus function will not work for ocular pathology (e.g. strong cataract), myopia and hyperopia (beyond -13 to +12D), etc.

 When the auto focus function is OFF, operate the focusing knob to change the split lines into one line on the color LCD monitor.

7 Operate the control lever until the two alignment bright spots are changed to one spot.

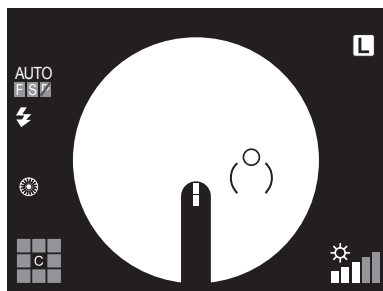

8 Operate the control lever and move the instrument body to bring the bright spot into the () scale on the color LCD monitor.

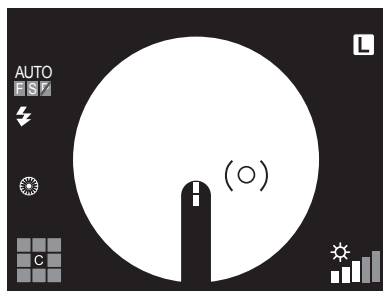

9 When the positional relation between the instrument body and the patient's eye is proper for photography, the instrument automatically takes a picture.



When flares appear in the peripheral section, the instrument does not take a picture automatically even if the auto shoot function is ON.

Check the bright spot on the color LCD monitor and press the **PHOTOGRAPHY SWITCH** to take a picture.



When the auto shoot function is OFF, the instrument does not take a picture automatically.

Check the bright spot on the color LCD monitor and press the **PHOTOGRAPHY SWITCH** to take a picture.



If you cannot align the split lines into one line by operating the focusing knob, change the diopter compensation lens.

For details, see "Changing the diopter compensation lens" on page 41.

Since the split lines are off when the diopter compensation lens is anything other than (0), turn the focusing knob so that the fundus image is clearly visible on the color LCD monitor.



If the split lines cannot be seen, check if the eye is obstructed by eyelashes or the eyelid.



Upon condition that the digital magnification mode is set, when the auto small pupil selector function is ON and small pupil is detected or when you take a picture by pressing the switch, the image is stored with the digital magnification 30° in IMAGEnet, etc. When the image is printed in this setting status, it is printed with the digital magnification 30°. When shipped, the digital magnification mode is not set. For details, contact your dealer or TOPCON (see the back cover).

RED-FREE PHOTOGRAPHY WITH RF FILTER

- 1** Pull out the RF filter selector toward you.

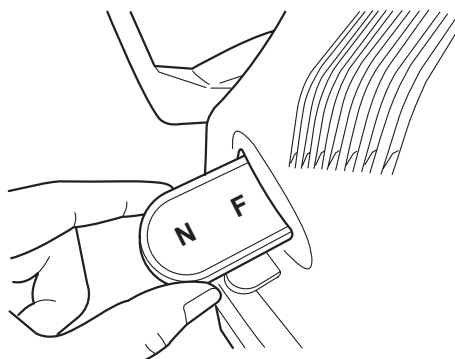

- 2**  The flash level is automatically changed (22W-s in ISO800) for red-free photography. For details about the flash level setting, refer to "Setting of the flash level" on page 40.

- 2** Hereafter, take a picture following the same procedure as "COLOR PHOTOGRAPHY (CENTER)" on page 39 or "PERIPHERAL PHOTOGRAPHY" on page 48.

ANTERIOR SEGMENT PHOTOGRAPHY

Setting the picture position

Set the fixation target in the center with the **FIXATION TARGET SELECTOR SWITCH**.

Setting the illumination level

Set the illumination level by pressing the **ILLUMINATION LEVEL SWITCH**.

See "Setting the illumination level" on page 39.

Setting the flash level

Set the flash level by pressing the **FLASH LEVEL SWITCH**.

See "Setting the flash level" on page 40.

Changing the diopter compensation lens

Push in the diopter compensation lens selector and change the diopter compensation lens to (0).

See "Changing the diopter compensation lens" on page 41.

Centering and photography

The centering operation is done with the control lever.

For details about movement/adjustment of the instrument body with the control lever, see the "MEMO" on page 42.

- 1** Hold the control lever and pull the instrument back toward the operator. Observe the anterior segment image on the color LCD monitor.

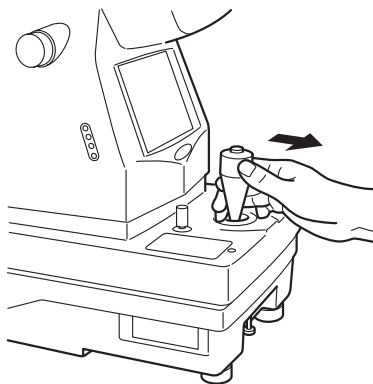

- 2 Move the instrument body in all directions by the control lever until the patient's eye is in the center of the color LCD monitor.

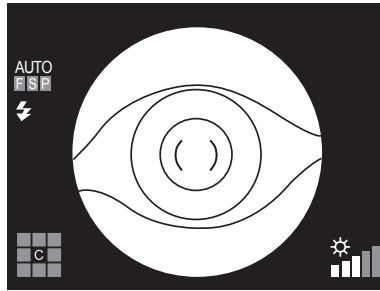

- 3 Turn the focusing knob so the anterior segment image is clearly visible on the color LCD monitor, and press the **PHOTOGRAPHY SWITCH**.

STEREO PHOTOGRAPHY

1 Press the **STEREO PHOTOGRAPHY SWITCH** on the Monitor screen.



The () scale is set vertically.

2 Move the instrument body by operating the control lever to bring the alignment bright spot into the () scale.

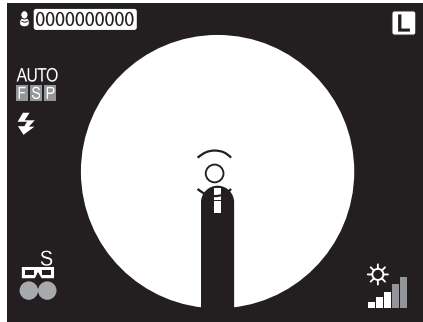

With this, focusing and positioning are done. Photography is not done yet.



With this, the () scale moves rightward.



When the auto focus function is ON, the focusing knob does not return to the initial position in stereo photography even if you pull the base unit toward you.



When the auto focus function is OFF, align the split line by turning the focusing knob.



When the auto shoot function is OFF, bring the alignment bright spot into the () scale and then press the **ENTER SWITCH**.

3 Bring the alignment bright spot into the () scale, which has already been moved rightward.

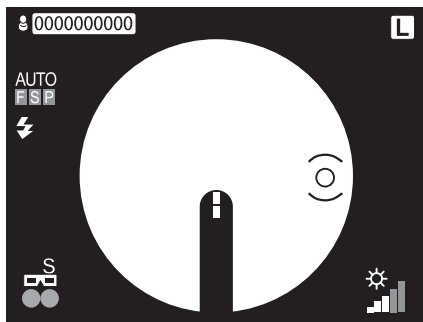

With this, the instrument takes a picture of the one side and the preview screen appears.



When the auto shoot function is OFF, bring the alignment bright spot into the () scale. Next, press the **PHOTOGRAPHY SWITCH** and then press the **ENTER SWITCH**.

4 After checking the preview screen, press the **PHOTOGRAPHY SWITCH**.



With this, the () scale moves leftward.



When you want to take a picture of the right side next, press the **ENTER SWITCH**.
The () scale moves from the left side to the right side and you can perform the operation of Step 3 again.

5 Bring the alignment bright spot into the () scale, which has already been moved leftward.

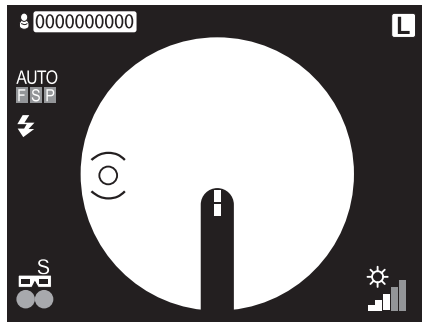

With this, the instrument takes a picture of the other side and the preview screen appears.



When the auto focus function is OFF, the operation is the same as the right side.

6 Press the **STEREO PHOTOGRAPHY SWITCH**.



With this, the stereo photography is finished and the normal monitor screen appears.



If you press the **ENTER SWITCH** before pressing the **STEREO PHOTOGRAPHY SWITCH**, the () scale moves right and left and it is possible to take additional pictures.

IMAGE PLAYBACK MODE

Reading the image



- 1** Press the **IMAGE PLAYBACK SWITCH** on the Monitor screen. The following screen is indicated on the color LCD monitor.



- 2** Press the **UPWARD CURSOR SWITCH** or **DOWNWARD CURSOR SWITCH** to select "SD CARD" or "USB MEMORY".
- 3** Press the **ENTER SWITCH** to decide the selected item. The image is read from the selected the recording medium.
-  In this condition, press the **LEFTWARD CURSOR SWITCH**, and the preceding photographed image is displayed. Press the **RIGHTWARD CURSOR SWITCH**, and the next photographed image is displayed.
- 4** To exit from the image playback mode, press the **IMAGE PLAYBACK SWITCH**.

Printing the image

When a digital printer applicable to Pict Bridge is connected to the instrument, direct print can be done.

- 1** Display the image to be printed on the color LCD monitor. For displaying it, refer to the above-mentioned "Reading the image".
 - 2** Make sure that the printer recognition icon  appears on the color LCD monitor and press the **PRINT SWITCH**. The screen to confirm whether the image should be printed or not appears. Select "CANCEL" to suspend printing, and "OK" to execute printing with the **LEFTWARD CURSOR SWITCH** or **RIGHTWARD CURSOR SWITCH**. Press the **PRINT SWITCH** again, and the image is printed.
-  When the preview screen appears right after taking a picture, the image is also printed by pressing the **PHOTOGRAPHY SWITCH**.

Deleting the image

- 1 Press the **IMAGE DELETION SWITCH** in the condition where the image is read. The following screen is indicated on the color LCD monitor.



- 2 Press the **UPWARD CURSOR SWITCH** or **DOWNWARD CURSOR SWITCH** to select "DELETE THIS" or "DELETE ALL".



When "DELETE THIS" is selected, the read image is deleted. When "DELETE ALL" is selected, all the images read from the recording medium are deleted.

- 3 The following check message is displayed on the color LCD monitor. To stop the deletion of the image, make sure that "CANCEL" is selected and then press the **ENTER SWITCH**. To delete the image, press the **LEFTWARD CURSOR SWITCH** or **RIGHTWARD CURSOR SWITCH**, select "OK" and then press the **ENTER SWITCH**.

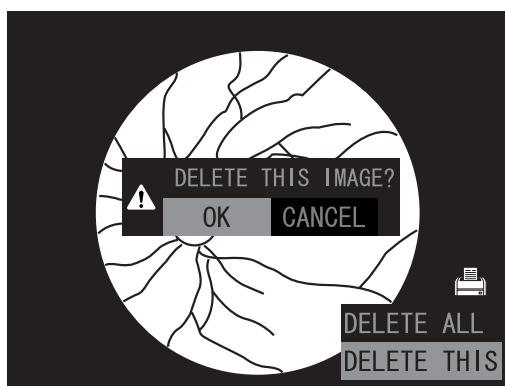

BEFORE REQUESTING SERVICE

TROUBLESHOOTING



Messages displayed during operation

Error message	Explanation	How to cancel
CHECK CAMERA!!	Camera connection error	Check the connection of the digital camera. If it is necessary to connect the camera again, turn OFF the power. Connect the camera correctly and then turn ON the power again.
NO SDCARD!!	The SD card is not inserted.	Insert the SD card or set "OFF" for the SD card.
SD FULL OR LOCKED!! (USB MEMORY FULL!!)	The SD card is locked or it does not have free capacity. (The USB memory does not have free capacity.)	Delete the images on the SD card (the USB memory). If they cannot be deleted, check if the SD card is locked.
CHECK USB!!	The destination for the USB connection is not found.	Check the connection of the USB. If it is necessary to connect the USB again, turn OFF the power. Connect the USB correctly and then turn ON the power again.
INTERLOCK ERROR!!	The cover is open.	Close the cover.
BATTERY EMPTY	The battery is run down.	Contact your dealer or TOPCON (see the back cover).



If any other error except the above has occurred, turn off the **POWER SWITCH** and contact your dealer or TOPCON (see the back cover).

Troubleshooting

 WARNING	To avoid electric shock, do not attempt disassembling, rebuilding and/or repairs on your own. Ask your dealer for repairs.
 WARNING	Do not remove the covers from the main unit, chinrest unit or power supply unit except for the lamp house cover. You may receive an electric shock.

When an error is encountered, review the Check List below.

If, after following the instructions below, you still cannot restore the instrument to a normal condition or if the problem does not fall into any of the categories below, contact your dealer or TOPCON (see the back cover).

Check List

Problem	Condition	Check	Page
Color LCD monitor does not work.	• Power cable is off the outlet/instrument.	Connect power cable.	22
	• Fuse has blown.	Change fuse.	76
	• Power save function is on (flickering power lamp).	Press Photography switch and cancel power save function.	35
Periphery of photographic image is dark.	• Centring is incorrect.	Adjust centering.	42
	• Focusing is incorrect.	Adjust focus.	44
	• Patient's pupil is not large enough.	Darken room and thoroughly dilate patient's pupil.	43
Photographic image is flared all over. (The whole is covered with light.)	• Centering is incorrect.	Adjust centering.	42
	• Focusing is incorrect.	Adjust focus.	44
	• Opacity in patient's eye.	Flare cannot be removed.	—
Photographic image has a dim white spot.	• Objective lens is stained.	Clean lens.	80
	• Eyelashes were in the way the moment the photograph was taken. (Dim light was seen at the screen bottom the moment the camera was aligned.)	Let patient open eye wider and take picture again. If not wide enough, open eyelid (i.e., Take picture holding eyelid open).	45
Photographic image is dark all over.	• Flash level is insufficient.	Adjust flash level (Flash level switch).	40
	• Xenon set screws are loose.	Refasten the xenon PCB.	75
	• Xenon lamp has served its life.	Change xenon lamp.	74
Illumination lamp does not turn on.	• Power save function is on (flickering power lamp).	Press Photography switch and cancel power save function.	35
	• Lamp terminal is loose.	Refasten lamp terminal.	74
	• Fuse has blown.	Change fuse.	76
	• The lamp has burned out.	Change lamp.	73
Internal fixation target cannot be seen.	• Centering is incorrect.	Adjust centering.	42
	• Setting is to external fixation target.	Reset to internal fixation target.	29
	• Fuse has blown	Change fuse.	76
() scale is off monitor center.	• Internal fixation target is set to periphery.	Press fixation target selector switch (reset) to set the fixation target in the center.	48

Problem	Condition	Check	Page
Split lines cannot be seen.	• Split line is set to OFF.	Turn split line ON (Split switch).	45
	• Diopter compensation lens selector is not set to (0).	Return diopter compensation lens selector to (0).	41
	• Patient's pupil is not large enough.	Darken room and thoroughly dilate patient's eye.	43
Xenon lamp does not turn on.	• Power save function is on (flickering power lamp).	Press Photography switch and cancel power save function.	35
	• Xenon lamp has served its life.	Change xenon lamp.	74
	• Cable connection is incorrect.	Make sure that the digital camera connecting cable is connected correctly.	20
	• Anomaly in external recording device.	Check power supply, settings, paper, etc.	—
Cannot get patient's pupil center.	• Is the patient's chin and forehead positioned correctly on the forehead rest and chinrest? Is the patient facing sideways?	Have patient correct their position.	38
	• Patient's face height is incorrect.	Adjust the face height with the chinrest switch.	38
Nothing is recorded in external recording device.	• Anomaly in external recording device.	Check power supply, settings, paper, etc.	—
	• Cable connections are incorrect.	Check and correct cable connections.	23

SPECIFICATIONS & PERFORMANCE

SPECIFICATIONS

Picture angle	45°
Working distance	40.7mm
Photographable area of pupil	φ4.0mm or more (φ3.3mm or more when the small pupil diaphragm is used)
Type of photography	Color photography and red-free photography
Focus range to correct the refractive errors of the patient's eye	0 : -13D to +12D *1) - : -33D to -12D + : +9D to +40D
Internal fixation target	Center/Periphery Right/left eye automatic detection Optional position presetting function
Auxiliary function for photography	Auto focus function (Used only in the split line working range. This can be turned ON/OFF.)
Base movement	Back-forth : 46mm Right-left : 100mm Up-down : 30mm
Chinrest movement	67mm

*1) Split line working range

* The design as well as specifications are subject to change without prior notice for the improvement.

Essential performance

- Photographing must be performed correctly.

ELECTROMAGNETIC COMPATIBILITY

This product conforms to the EMC Standard(IEC 60601-1-2 Ed.3.0: 2007).

- a) MEDICAL ELECTRICAL EQUIPMENT needs special precautions regarding EMC and needs to be installed and put into service according to the EMC information provided in the ACCOMPANYING DOCUMENTS.
- b) Portable and mobile RF communications equipment can affect MEDICAL ELECTRICAL EQUIPMENT.
- c) The use of ACCESSORIES, transducers and cables other than those specified, with the exception of transducers and cables sold by the manufacturer of the EQUIPMENT or SYSTEM as replacement parts for internal components, may result in increased EMISSIONS or decreased IMMUNITY of the EQUIPMENT or SYSTEM.
- d) The EQUIPMENT or SYSTEM should not be used adjacent to or stacked with other equipment. IF adjacent or stacked use is necessary, the EQUIPMENT or SYSTEM should be observed to verify normal operation in the configuration in which it will be used.
- e) The use of the ACCESSORY, transducer or cable with EQUIPMENT and SYSTEMS other than those specified may result in increased EMISSION or decreased IMMUNITY of the EQUIPMENT or SYSTEM.

Item	Parts code	Length (m)
AC power cord	44804 7002	1.5
USB cable	—	2.0
USB cable	—	2.0
USB cable (for USB keyboard)	—	2.0
USB cable (for USB mouse)	—	1.5
PHO.CAM_CNT D80 (for remote control)	40508 66100	0.35
PHO.CAM_CNT D80 (for syncro)	40508 66100	0.35
PHO.CAM_CNT D90 (for remote control)	40508 69700	0.35
PHO.CAM_CNT D90 (for syncro)	40508 69700	0.35
PHO.CAM_POW_CBL	40508 66300	0.44
PHO.CAM_USB_D80	40508 68900	0.5

Guidance and manufacturer's declaration - electromagnetic emissions		
The TRC-NW8 is intended for use in the electromagnetic environment specified below. The customer or the user of the TRC-NW8 should assure that it is used in such an environment.		
Emissions test	Compliance	Electromagnetic environment - guidance
RF emissions CISPR 11	Group 1	The TRC-NW8 uses RF energy only for its internal function. Therefore, its RF emissions are very low and are not likely to cause any interference in nearby electronic equipment. The TRC-NW8 is suitable for use in all establishments including domestic and those directly connected to the public low-voltage power supply network that supplies buildings used for domestic purposes.
RF emissions CISPR 11	Class B	
Harmonic emissions IEC61000-3-2	Class A	
Voltage fluctuations/ flicker emissions IEC61000-3-3	Complies	

Guidance and manufacturer's declaration - electromagnetic immunity

The TRC-NW8 is intended for use in the electromagnetic environment specified below. The customer or the user of the TRC-NW8 should assure that it is used in such an environment.

Immunity test	IEC 60601 test level	Compliance level	Electromagnetic environment - guidance
Electrostatic discharge (ESD) IEC 61000-4-2	±6 kV contact ±8 kV air	±6 kV contact ±8 kV air	Floors should be wood, concrete or ceramic tile. If floors are covered with synthetic material, the relative humidity should be at least 30%.
Electrical fast transient/burst IEC 61000-4-4	±2 kV for power supply lines ±1 kV for input/output lines	±2 kV for power supply lines ±1 kV for input/output lines	Mains power quality should be that of a typical commercial or hospital environment.
Surge IEC 61000-4-5	±1 kV line(s) to line(s) ±2 kV line(s) to earth	±1 kV line(s) to line(s) ±2 kV line(s) to earth	Mains power quality should be that of a typical commercial or hospital environment.
Voltage dips, short interruptions and voltage variations on power supply input lines IEC 61000-4-11	<5% U_t (>95% dip in U_t) for 0.5 cycle 40% U_t (60% dip in U_t) for 5 cycles 70% U_t (30% dip in U_t) for 25 cycles <5% U_t (>95% dip in U_t) for 5 sec	<5% U_t (>95% dip in U_t) for 0.5 cycle 40% U_t (60% dip in U_t) for 5 cycles 70% U_t (30% dip in U_t) for 25 cycles <5% U_t (>95% dip in U_t) for 5 sec	Mains power quality should be that of a typical commercial or hospital environment. If the user or the TRC-NW8 requires continued operation during power mains interruptions, it is recommended that the TRC-NW8 be powered from an uninterruptible power supply or battery.
Power frequency (50/60 Hz) magnetic field IEC 61000-4-8	3 A/m	3 A/m	Power frequency magnetic fields should be at levels characteristic of a typical location in a typical commercial or hospital environment.
NOTE U_t is the a.c. mains voltage prior to application of the test level.			

Guidance and manufacturer's declaration - electromagnetic immunity

The TRC-NW8 is intended for use in the electromagnetic environment specified below. The customer or the user of the TRC-NW8 should assure that it is used in such an environment.

Immunity test	IEC 60601 test level	Compliance level	Electromagnetic environment-guidance
<p>Conducted RF IEC 61000-4-6</p> <p>Radiated RF IEC 61000-4-3</p>	<p>3 Vrms 150kHz to 80MHz</p> <p>3 V/m 80MHz to 2.5GHz</p>	<p>3 V</p> <p>3 V/m</p>	<p>Portable and mobile RF communications equipment should be used no closer to any part of the TRC-NW8, including cables, than the recommended separation distance calculated from the equation applicable to the frequency of the transmitter.</p> <p>Recommended separation distance</p> $d = 1.2\sqrt{P}$ <p>$d = 1.2\sqrt{P}$ 80MHz to 800MHz</p> <p>$d = 2.3\sqrt{P}$ 80MHz to 2.5GHz</p> <p>where P is the maximum output power rating of the transmitter in watts (W) according to the transmitter manufacturer and d is the recommended separation distance in meters (m).</p> <p>Field strengths from fixed RF transmitters, as determined by an electromagnetic site survey, ^a should be less than the compliance level in each frequency range. ^b</p> <p>Interference may occur in the vicinity of equipment marked with the following symbol:</p> 

NOTE 1 At 80 MHz and 800 MHz, the higher frequency range applies.
 NOTE 2 These guidelines may not apply in all situations. Electromagnetic propagation is affected by absorption and reflection from structures, objects and people.

^a Field strengths from fixed transmitters, such as base stations for radio (cellular/cordless) telephones and land mobile radios, amateur radio, AM and FM radio broadcast and TV broadcast cannot be predicted theoretically with accuracy. To assess the electromagnetic environment due to fixed RF transmitters, an electromagnetic site survey should be considered. If the measured field strength in the location in which the TRC-NW8 is used exceeds the applicable RF compliance level above, the TRC-NW8 should be observed to verify normal operation. If abnormal performance is observed, additional measures may be necessary, such as reorienting or relocating the TRC-NW8.

^b Over the frequency range 150 kHz to 80 MHz, field strengths should be less than 3 V/m.

Recommended separation distance between portable and mobile RF communications equipment and the TRC-NW8

The TRC-NW8 is intended for use in an electromagnetic environment in which radiated RF disturbances are controlled. The customer or the user of the TRC-NW8 can help prevent electromagnetic interference by maintaining a minimum distance between portable and mobile RF communications equipment (transmitters) and the TRC-NW8 as recommended below, according to the maximum output power of the communications equipment.

Rated maximum output power of transmitter W	Separation distance according to frequency of transmitter m		
	150kHz to 80MHz $d = 1.2\sqrt{P}$	80MHz to 800MHz $d = 1.2\sqrt{P}$	800MHz to 2.5GHz $d = 2.3\sqrt{P}$
0.01	0.12	0.12	0.23
0.1	0.38	0.38	0.73
1	1.2	1.2	2.3
10	3.8	3.8	7.3
100	12	12	23

For transmitters rated at a maximum output power not listed above, the recommended separation distance d in meters (m) can be estimated using the equation applicable to the frequency of the transmitter, where P is the maximum output power rating of the transmitter in watts (W) according to the transmitter manufacturer.

NOTE 1 At 80 MHz and 800 MHz, the separation distance for the higher frequency range applies.

NOTE 2 These guidelines may not apply in all situations. Electromagnetic propagation is affected by absorption and reflection from structures, objects and people.

ELECTRIC RATING

Source voltage : AC100-120V/200-240V 50-60Hz

Power input : NORMAL 100VA MAXIMUM 400VA

SYSTEM CLASSIFICATION

Types of protection against electric shocks: This instrument is classified as Class I equipment.

Class I equipment does not depend only on basic insulation for protection against electric shocks, but also provides a means of connection to a protective earth system of facilities so that metal parts that come into contact do not become conductive while the basic insulation is in failure.

Degree of protection against electric shocks: Type B applied part

Type B applied part is the applied part complying with the specified requirements of the Standard IEC 60601-1 to provide protection against electric shock, particularly regarding allowable LEAKAGE CURRENT.

Degree of protection against harmful ingress of water: IPX0

The TRC-NW8 has no protection against ingress of water. (The degree of protection against harmful ingress of water defined in IEC 60529 is IPX0.)

Classification according to the method(s) of sterilization or disinfection recommended by the manufacturer: not applicable.

The TRC-NW8 has no part to be sterilized or to be disinfected.

Classification according to the degree of safety of application in the presence of a flammable anesthetic mixture with air or with oxygen or nitrous oxide: Equipment not suitable for use in the presence of a flammable anesthetic mixture with air or with oxygen or nitrous oxide.

The TRC-NW8 should be used in environments where no flammable anesthetics and/or flammable gases are present.

Classification according to the mode of operation: Continuous operation.

Continuous operation is the operation under normal load for an unlimited period, without the specified limits of temperature being exceeded.

DIMENSIONS AND WEIGHT

Dimensions : 274mm (W) × 508mm (D) × 536 - 566mm (H)

Weight : 23.5kg

PURPOSE OF USE

To observe and photograph the fundus through the pupil and document it.



OPERATION PRINCIPLE

The fundus of the patient's eye is illuminated by the infrared light emitted from the illumination optical system. The observation CCD camera built into the instrument receives the image and the image is indicated on the color LCD monitor allowing the operator to observe the fundus. After adjusting the photography position and focus, the visible light is emitted from the illumination optical system provided for photography by operating the photography switch of the instrument. The digital camera, which is connected to the instrument, receives the image and then the image is recorded in the memory card built into the digital camera or the connected image filing system or external recording device, which is a commercial product.

The fundus of the patient's eye can also be illuminated, observed and photographed by the visible light after removing the IR filter from the illumination optical system. Moreover, it is possible to perform red-free observation and photography by inserting the RF filter into the illumination optical system.

MAINTENANCE

DAILY CHECKUPS

 CAUTION	To prevent damage and injuries, do not install the instrument on an uneven, unsteady or sloping surface.
 CAUTION	To avoid injury by falling off, make sure that the digital camera is correctly installed.

Daily care

- Dust is a formidable foe to the instrument.
 To ensure the production of fine images, care should be taken not to allow fingerprints and/or dirt on the objective lens.
 When not in use, be sure to cap the objective lens and cover the instrument with the dust cover.
 If the objective lens is stained, clean it following the instructions for "Cleaning the objective lens" on page 80.
- When not in use, always turn the **POWER SWITCH** OFF (○).

Ordering consumables

- When ordering consumables and spare parts, contact your dealer or TOPCON (see the back cover) and tell them the article name, article code and quantity.

Article name	Article code
Illumination lamp	40531 1817
Xenon lamp	40531 1810
Chinrest tissue paper	40310 4082
Dust cover	40488 1007

Article name	Article code
Fuse 5A 125V	T2400 0166A
Fuse 2.5A 250V	T2400 0157A

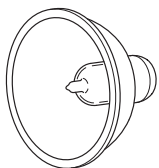

Illumination lamp

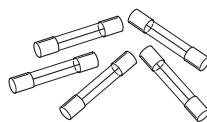

Fuse



Dust cover

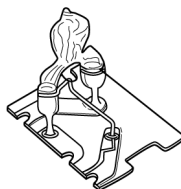

Xenon lamp

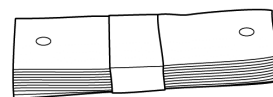

Chinrest tissue paper



User maintenance items

Item	Inspection time	Contents
Inspection	Before using	<ul style="list-style-type: none">• The instrument must operate correctly.• The objective lens must be free of stain or flaw.
Cleaning	When the part is stained	<ul style="list-style-type: none">• Objective lens• External cover, control panel, etc.
Replacement	As required	<ul style="list-style-type: none">• Illumination lamp• Xenon lamp• Fuse

Manufacturer maintenance items

Item	Inspection time	Contents
Cleaning each unit	At least every 12 months	<ul style="list-style-type: none">• Cleaning the external parts• Cleaning the optical system• Cleaning the base unit
Operation check	At least every 12 months	<ul style="list-style-type: none">• Operation of the instrument• Operation of switches
Photography check	At least every 12 months	<ul style="list-style-type: none">• Focus, flare, central ghost and dust• Check the flash level.• Check the illumination level.

Replacing the illumination lamp

 CAUTION	To avoid electric shock, be sure to turn the power switch off and unplug the power cord before replacing the lamp.
 CAUTION	To avoid burns, allow lamp to cool before touching.
NOTE	To avoid whitening due to fingerprints, do not touch the lamp with bare fingers.
NOTE	Since the lamp is not shock resistant, handle it with particular care.

- The service life of the illumination lamp is approx. 2,000 hours.
Replace the illumination lamp if it is burned or becomes whitened.

- 1** Turn the **POWER SWITCH** OFF (○) and unplug the power cord.
- 2** Turn the control lever and raise the instrument body to it's limit.
- 3** Unscrew the lamp house cover with a coin, etc. to remove it.
- 4** Loosen the two set screws and remove the lamp terminal.

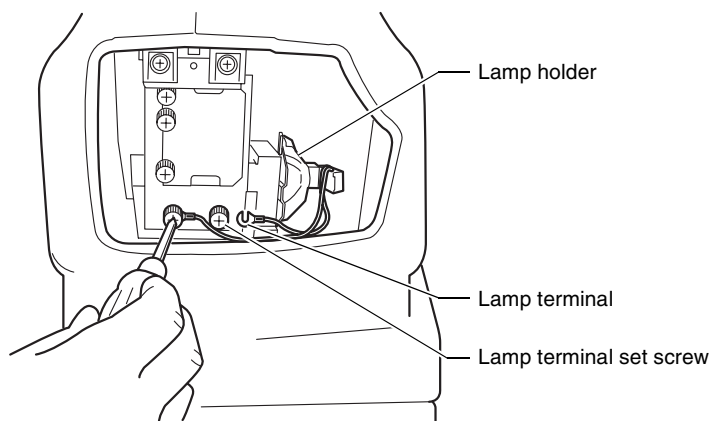

- 5** Hold the lamp at the bottom, and pull it out of the lamp holder, in a straight direction.

- 6** Hold the new lamp and slide it into the lamp holder until it stops at the end. Make sure that the lamp is firmly fixed in the lamp holder.

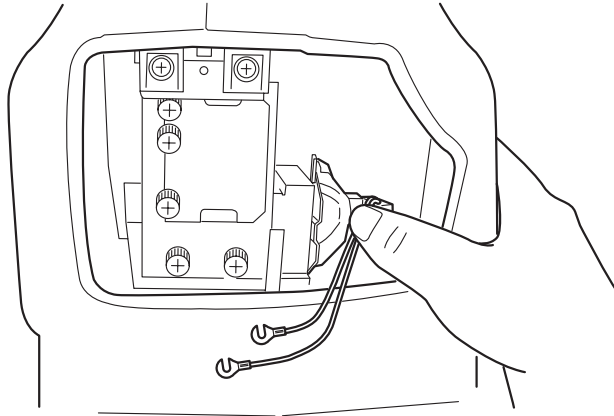

- 7** Fasten the lamp terminal securely with the two set screws.
- 8** Attach the lamp house cover by matching the projection at the bottom part of the lamp house cover with the groove of the body cover. Turn the screws with a coin, etc. and securely fasten the lamp house cover.



To avoid electric shock, if the lamp house cover is left unfixed, an error is displayed on the color LCD monitor and operations, including photography, cannot be done.

Replacing the xenon lamp

⚠ CAUTION	To avoid electric shock, be sure to turn the power switch off and unplug the power cord before replacing the lamp.
⚠ CAUTION	To avoid electric shock, do not touch the xenon lamp immediately after it flashes or burns out.
NOTE	To avoid whitening due to fingerprints, do not touch the lamp with bare fingers.
NOTE	Since the lamp is not shock resistant, handle it with particular care.

- The service life of the xenon lamp is approx. 10,000 cycles.
Replacing the xenon lamp if it is burned or becomes whitened:

- 1** Turn the **POWER SWITCH** OFF (○) and wait for more than 5 minutes for the natural electrical discharge. Then, unplug the power cord.
- 2** Unscrew the lamp house cover with a coin, etc. to remove it.

3 Loosen the three xenon set screws.

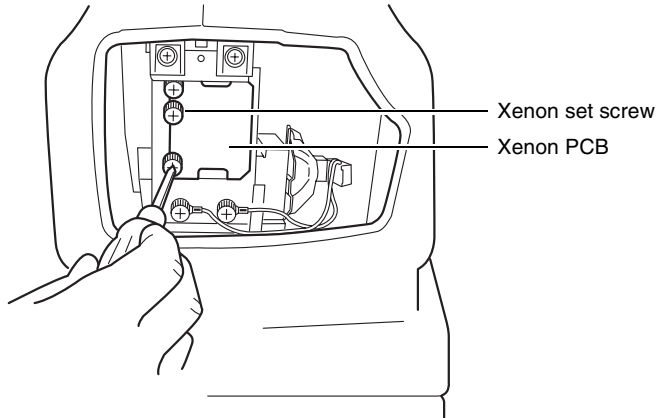

4 Hold the xenon PCB at the top and the bottom, slightly slide it to the right and pull it out straight toward the operator side.

5 Insert the new xenon PCB, so the xenon lamp does not touch the surrounding metal components, and upon reaching the stopper, slightly move it to the left and slide it into the xenon set screws.

6 Securely fasten the three xenon set screws.

7 Attach the lamp house cover by matching the projection at the bottom part of the lamp house cover with the groove of the body cover. Turn the screws with a coin, etc. and securely fasten the lamp house cover.



To avoid electric shock, if the lamp house cover is left unfixated, an error is displayed on the color LCD monitor and operations, including photography, cannot be done.

Changing the fuse



WARNING

To avoid electric shock, unplug the power cord from the grounded outlet before removing the fuse cover. Do not connect the power cord to the grounded outlet with the fuse cover left unfixed.



WARNING

To avoid fire in the event of an instrument malfunction, use only fuses that are fitted to the marked label at the side of the fuse holder.

- 1 Turn the **POWER SWITCH** OFF (○) and unplug the power cord.
- 2 With a slotted screwdriver, press and turn the fuse holder counterclockwise and remove it.

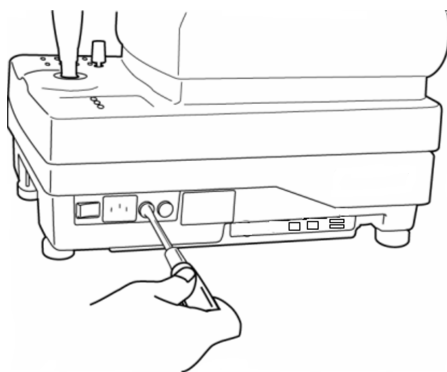

- 3 Replace the fuse with a new fuse of the same capacity.

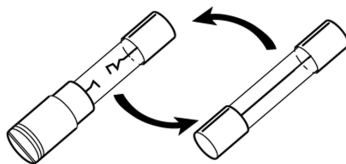

Changing the fuse

- 4 With a slotted screwdriver, lightly press and turn the fuse holder clockwise and fasten it.



When the fuse has blown out, the entire instrument will not operate. Replace the fuse.

Supplying the chinrest tissue paper

- When the chinrest tissue paper is used up, pull out the chinrest tissue pin and refill the tissue paper.

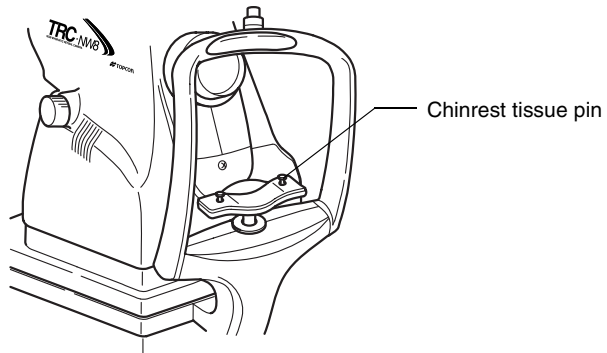

Adjusting the color LCD monitor

- This instrument is adjusted for the best image quality before shipment, however, readjustment may be required due to influences, including vibrations, during transportation.
- The image quality adjustment switch is on the left side of the color LCD monitor. Contact your dealer for further adjustment of the image quality.
- Names of switches

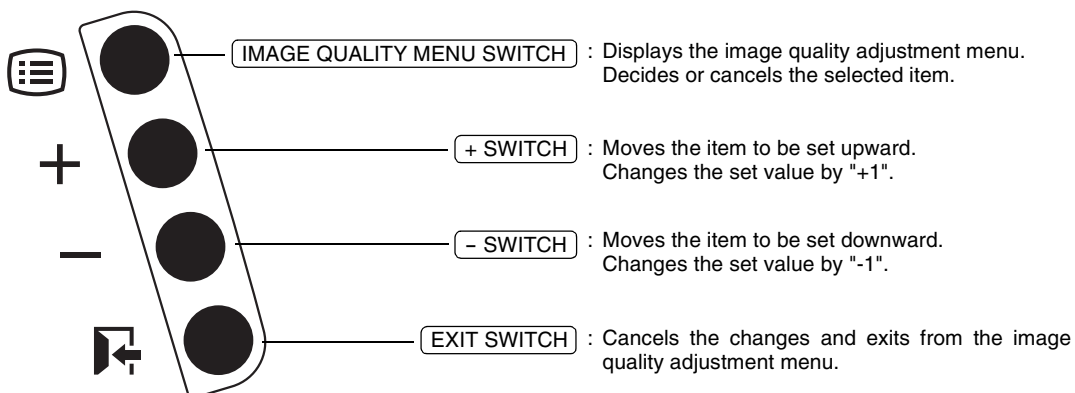

- Image quality adjustment procedure of the color LCD monitor

- 1** Press the **IMAGE QUALITY MENU SWITCH**, and the image quality adjustment menu appears on the color LCD monitor.

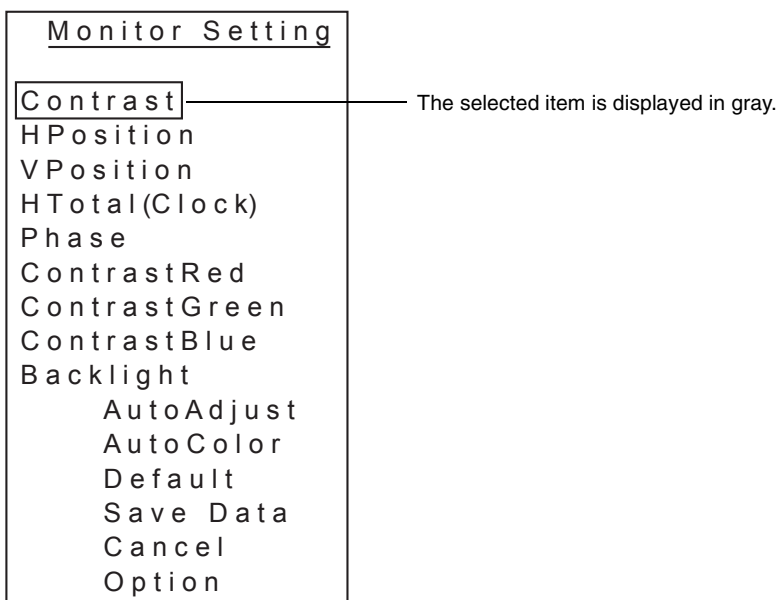

- 2** Press the **+ SWITCH** or **- SWITCH** to move to a desirable item.
- 3** Press the **IMAGE QUALITY MENU SWITCH**. The selected item color is changed to yellow and you can change the set value.
- 4** Change the set value of the selected item with the **+ SWITCH** or **- SWITCH**.
- 5** Press the **IMAGE QUALITY MENU SWITCH**. The set value is decided and the selected item color is changed to gray.

6 If you want to change other items, repeat Step **2** to **5**.

7 Select "Save Data" and press the **IMAGE QUALITY MENU SWITCH**. The set value is saved and the image quality adjustment menu disappears.



When the switches are not operated for 10 seconds or more during setting, the setting procedure is finished, the set value is saved and the image quality adjustment menu disappears.

- Items and contents for image quality adjustment

Page 1

Set item	Contents
Contrast	Adjusts the contrast for all RGB colors.
HPosition	Adjusts the horizontal position.
VPosition	Adjusts the vertical position.
Htotal (clock)	Sets the horizontal total number.
Phase	Sets the phase. (Glimmer adjustment)
Contrast Red	Adjusts the red contrast. (Digital setting)
Contrast Green	Adjusts the green contrast. (Digital setting)
Contrast Blue	Adjusts the blue contrast. (Digital setting)
Backlight	Adjusts the brightness.
Auto Adjust	Adjusts the position automatically.
Auto Color	Adjusts the color automatically.
Default	Returns the set data to the condition when shipped.
Save Data	Saves the set data.
Cancel	Cancels the data and erases the image quality adjustment menu.
Option	Displays page 2.

Page 2

Set item	Contents
Red Gain	Adjusts the red ADC gain. (Analog setting)
Green Gain	Adjusts the green ADC gain. (Analog setting)
Blue Gain	Adjusts the blue ADC gain. (Analog setting)
Red Offset	Adjusts the red ADC offset. (Analog setting)
Green Offset	Adjusts the green ADC offset. (Analog setting)
Blue Offset	Adjusts the blue ADC offset. (Analog setting)
Filter	Sets the space filter.
Gamma	Sets the gamma value.
OSD HPosition	Adjusts the horizontal position of the image quality adjustment menu screen.
OSD VPosition	Adjusts the vertical position of the image quality adjustment menu screen.
OSD Effect	Sets the transparent effect of the image quality adjustment menu screen.
OSD Time Out	Sets the "OFF" time of the image quality adjustment menu screen.
Default	Returns the set data to the condition when shipped.
Save Data	Saves the set data.
Cancel	Displays page 1.

CLEANING

Cleaning the external cover, control panel and color LCD monitor screen

NOTE	To prevent the plastic parts of the instrument body from discoloring and deteriorating, do not use volatile solvents for cleaning, including benzene, thinner, ether, gasoline, etc.
-------------	--

- 1** When the external cover, control panel and color LCD monitor screen become stained, clean them with a dry cloth.
- 2** If the external cover is badly stained, prepare a tepid solution of neutral detergent for kitchenware. Moisten the cloth with the aforementioned solution and wring it thoroughly. Then wipe the cover with the cloth.

Cleaning the parts which come into contact with the patient

Before and after using the instrument and when one patient alternates with another, clean the parts with a clean gauze pad moistened with sterilizing alcohol.

Cleaning the objective lens

When the objective lens is stained, clean it according to the following procedure. The dust-proof coated objective lens is used in this instrument. The wiping method is different from a conventional coated lens.

- To check the objective lens, set the **POWER SWITCH** to "ON" (|) and turn the illumination lamp ON.

Darken the room. Pull out the IR filter selector and set the visible light for the observation illumination.

Press the **ILLUMINATION LEVEL SWITCH (+)** four times to set the maximum light intensity.

Examine the objective lens diagonally from the front. The lens condition can be seen clearly.

- Dust and dirt adhered to the surface
Blow them off using a blower.
Be careful to prevent the blower end from touching the objective lens.

- When the stain is simple such as dust, tears or saliva:

- 1** Breathe toward the objective lens and wipe it with a lens cleaning paper carefully.
- 2** If your lens cleaning paper is dirty, replace it with a clean one and repeat step **1**.
- 3** Repeat steps **1** and **2** until no stain is seen on the lens.

- When the stain is persistent:

- 1** Moisten a lens cleaning paper with reagent ethanol properly. Wipe the objective lens with the lens cleaning paper by rubbing lightly.
- 2** If your lens cleaning paper is dirty, replace it with clean one and repeat step **1**.
- 3** Repeat steps **1** and **2** until no stain is seen on the lens.
- 4** Finally, wipe the objective lens with a dry lens cleaning paper. It is o.k. to wipe the lens after breathing on it.



Don't use the following methods because the lens can be damaged.

- Wiping the lens by grasping with fingernails
- Using a lens cleaning paper wound around a hard tool (for example, a metallic tool)



Use a soft lens cleaning paper without fiber.

- For example, BEMCOT (Asahikasei)



Don't let any strong-alkaline liquid adhere to the objective lens.

If such liquid adheres to the lens, immediately wipe it off.



If it is difficult to remove a stain from the objective lens, contact your dealer or TOPCON (see the back cover).

OPTIONAL ACCESSORIES

EXTERNAL FIXATION TARGET EF-2

This is used to guide the patient's fixed sight.

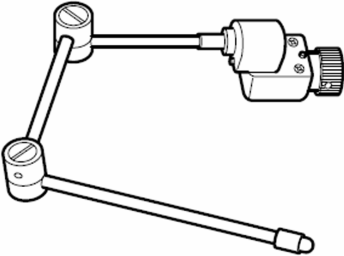





REFERENCE MATERIAL

SHAPE OF PLUG

Country	Voltage/frequency	Shape of plug
Mexico	110V/50Hz	Type C&E
Argentina	220V/60Hz	Type A
Peru	220V/60Hz	Type A
Venezuela	110V/50Hz	Type C&E
Bolivia & Paraguay	220V/60Hz	Type A (Most common) Type H (Infrequently)
Chile	220V/60Hz	Type A
Colombia	110V/50Hz	Type C
Brazil	220V/60Hz 127V/60Hz	Type A Type C
Ecuador	110V/50Hz	Type C&E
USA	120V/60Hz	Type A (Hospital Grade)
Canada	120V/60Hz	Type A (Hospital Grade)

SYMBOL

Symbol	IEC Publication	Description	Description (French)
	60417-5032	Alternating Current	Courant alternatif
	60348	Attention, consult accompanying documents	Attention, consulter les documents d'accompagnement
	60417-5008	Off (power: disconnection from the main power supply)	Éteint (courant: coupure avec le secteur)
	60417-5007	On (power: connection to the main power supply)	Allumé (courant: raccordement sur le secteur)
	60878-02-02	Type B applied part	Partie appliquée du Type B

USABLE AUTOMATIC INSTRUMENT TABLE

Automatic instrument table AIT-16

Because the instrument height can be adjusted to the desired position, you can take a picture more easily.

Specifications

- Dimensions525 (W) × 490 (D) mm
- Table height.....660 - 880mm
- Table size490 × 500mm
- Weight.....Approx. 23kg (only the instrument body)
- Power consumption220VA
- Maximum load.....50kg

RELATION BETWEEN SETTING OF ILLUMINATION/ FLASH LEVEL AND MAXIMUM RADIANCE

When the maximum radiance is "1", the ratio of radiance is shown below in setting of illumination/
flash level.

Illumination level

Indicated set value	Level ratio
1	0.277
2	0.366
3	0.497
4	0.669
5	1.000

Flash level

Indicated set value	Level ratio
0.7	0.022
0.8	0.025
1.0	0.027
1.2	0.033
1.4	0.036
1.7	0.041
2.0	0.047
2.3	0.054
2.8	0.063
3.3	0.070
3.9	0.081
4.7	0.100
5.6	0.114
6.6	0.131
7.9	0.154
9.4	0.177
11	0.203
13	0.233
16	0.268
19	0.291
22	0.334
27	0.411
32	0.507
38	0.616
45	0.707
53	0.812
63	1.000

INFORMATION ABOUT THE OPTICAL RADIATION HAZARD TO THE USER

Relative spectral output of this instrument

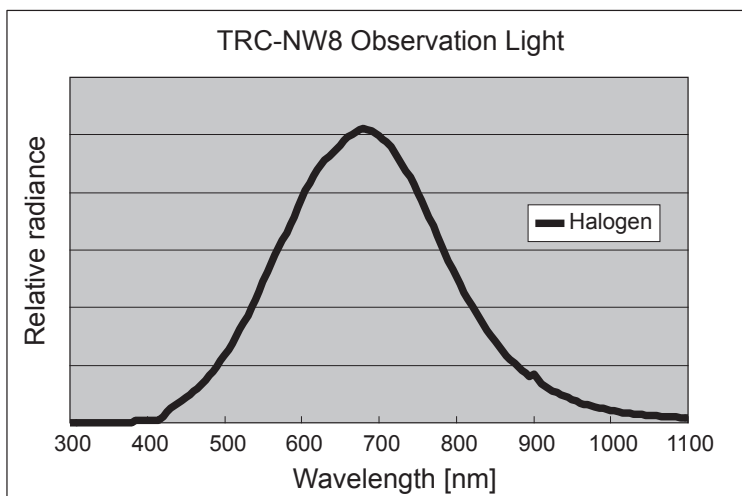

Photochemical light source radiance of this instrument

LA (without crystalline lens) : 0.48 mW/ (cm²·sr)

LB (with crystalline lens) : 0.45 mW/ (cm²·sr)

Meaning of LA and LB

- Spectrally weighted photochemical radiances LB and LA give a measure of the potential that exists for a beam of light to cause photochemical hazard to the retina. LB gives the measure for eyes in which the crystalline lens is in place. LA gives this measure either for eyes in which the crystalline lens has been removed (aphakes) and has not been replaced by a UV-blocking lens or for eyes of very young children.
- The value stated for TRC-NW8 gives a measure of hazard potential when the instrument is operated at maximum intensity and maximum aperture. Values of LB or LA over 80mW/ (cm²·sr) are considered high for beams which wholly fill a dilated pupil.
- Because prolonged intense light exposure can damage the retina, the use of the device for ocular examination should not be unnecessarily prolonged, and the brightness setting should not exceed what is needed to provide clear visualization of the target structures. This device should be used with filter that eliminate UV radiation (<400 nm) and, whenever possible, filters that eliminate short-wavelength blue light (<420 nm).
- The retinal exposure dose for a photochemical hazard is a product of the radiance and the exposure time. If the value of radiance were reduced in half, twice the time would be needed to reach the maximum exposure limit.
- While no acute optical radiation hazards have been identified for fundus cameras, it is recommended that the intensity of light directed into the patient's eye be limited to the minimum level which is necessary for diagnosis. Infants, aphakes and persons with diseased eyes will be at greater risk. The risk may also be increased if the person being examined has had any exposure with the same instrument or any other ophthalmic instrument using a visible light source during the previous 24 hours. This will apply particularly if the eye has been exposed to retinal photography.

When calling please give us the following information about your unit:

- Model name: TRC-NW8
- Serial No.: Shown on the rating plate on the right side of the power unit
- Period of use: Please inform us of the date of purchase.
- Instrument's condition: Please provide us with as much detail as possible on the problem.

NON-MYDRIATIC RETINAL CAMERA (TRC-NW8)

INSTRUCTION MANUAL

2010 version (2010.8-100TH^⑤)

Date of issue: August 27, 2010

Published by TOPCON CORPORATION

75-1 Hasunuma-cho, Itabashi-ku, Tokyo, 174-8580 Japan.

NON-MYDRIATIC RETINAL CAMERA

TRC-NW8

TOPCON MEDICAL SYSTEMS, INC.

111 Bauer Drive, Oakland, NJ 07436, USA Phone:+1-201-599-5100 Fax:+1-201-599-5248 www.topconmedical.com

TOPCON CANADA INC.

110 Provencher Avenue, Boisbriand, QC J7G 1N1 CANADA Phone:+1-450-430-7771 Fax:+1-450-430-6457 www.topcon.ca

TOPCON EUROPE MEDICAL B.V.

(European Representative)(European Sole Sales Company)

Essebaan 11; 2908 LJ Capelle a/d IJssel; P.O.Box145; 2900 AC Capelle a/d IJssel; THE NETHERLANDS

Phone:+31 -(0)10-4585077 Fax:+31 -(0)10-4585045 E-mail: medical@topcon.nl; www.topcon.eu

ITALY OFFICE

:Viale dell' Industria 60; 20037 Paderno Dugnano; (Milano), ITALY Phone:+39-02-9186671 Fax:+39-02-91081091 E-mail: topconitaly@tiscali.it; www.topcon.it

DANMARK OFFICE

:Praestemarksvej 25; 4000 Roskilde, DANMARK Phone:+45-46-327500 Fax:+45-46-327555 E-mail: topcon@topcondanmark.dk www.topcondanmark.dk

IRELAND OFFICE

:Unit 276, Blanchardstown; Corporate Park 2 Ballycoolin Dublin 15, IRELAND Phone:+353-18975900 Fax:+353-18293915 E-mail: medical@topcon.ie; www.topcon.ie

TOPCON DEUTSCHLAND G.m.b.H.

Hanns-Martin-Schleyer Strasse 41; D-47877 Willich, GERMANY Phone:+49-(0)2154-8850 Fax:+49-(0)2154-885177 E-mail:med@topcon.de; www.topcon.de

TOPCON ESPAÑA S.A.

HEAD OFFICE:Frederic Mompou 4 Esc. A Bajos 3, 08960 Sant Just Desvern Barcelona, Spain Phone:+34-93-4734057 Fax:+34-93-4733932 E-mail: medica@topcon.es; www.topcon.es

PORTUGAL OFFICE:Rua da Forte,6-6A,L-0.22,2790-072 Camaxide, PORTUGAL Phone:+351-210-994626 Fax:+351-210-938786 www.topcon.pt

TOPCON S.A.R.L.

89, rue de Paris 92585 Clichy, FRANCE Phone:+33-(0)1-41069494 Fax:+33-(0)1-47390251 E-mail:topcon@topcon.fr; www.topcon.fr

TOPCON SCANDINAVIA A.B.

Neogatan 2; P.O.Box 25; 43151 Mölndal, SWEDEN Phone:+46-(0)31-7109200 Fax:+46-(0)31-7109249 E-mail:medical@topcon.se; www.topcon.se

TOPCON (GREAT BRITAIN) LTD.

Topcon House,Kennet Side,Bone Lane,Newbury,Berkshire RG14 5PX United Kingdom

Phone:+44-(0)1635-551120 Fax:+44-(0)1635-551170 E-mail: info@topcon.co.uk; www.topcon.co.uk

TOPCON POLSKA Sp. z o. o.

ul. Warszawska 23; 42-470 Siewierz, POLAND Phone:+48-(0)32-6705045 Fax:+48-(0)32-6713405 www.topcon-polska.pl

TOPCON SINGAPORE MEDICAL PTE. LTD.

60 Alexandra Terrace, #08-27 The Comtech, SINGAPORE 118502 Phone:+65-68720606 Fax:+65-67736150 www.topcon.com.sg

TOPCON INSTRUMENTS (MALAYSIA) SDN.BHD.

No. D1, (Ground Floor), Jalan Excella 2, Off Jalan Ampang Putra, Taman Ampang Hilir, 55100 Kuala Lumpur, MALAYSIA Phone:+60-(0)3-42709866 Fax:+60-(0)3-42709766

TOPCON INSTRUMENTS (THAILAND) CO.,LTD.

77/162 Sinnsathorn Tower, 37th Floor, Krungthonburi Rd., Klongtongsai, Klongsarn, Bangkok 10600, THAILAND Phone:+66(0)2-440-1152~7 Fax:+66-(0)2-440-1158

TOPCON CORPORATION BEIJING OFFICE

Block No.9, Kangding Street, Beijing Economic-Technological Development Area, Beijing,100176, CHINA Phone:+86-(0)10-6780-2799 Fax:+86-(0)10-6780-2790

TOPCON CORPORATION SHANGHAI OFFICE

14L Huamin Empire Plaza, No.726, Yan-an Xi Road, Shanghai, 200050, CHINA Phone:+86-(0)21-5238-7722 Fax:+86-(0)21-5237-0761

TOPCON CORPORATION BEIRUT OFFICE

P.O.Box 70-1002 Antelias,Beirut, LEBANON Phone:+961-4-523525/523526 Fax:+961-4-521119

TOPCON CORPORATION DUBAI OFFICE

P.O.Box 293705, Dubai Airport Free Zone L.I.U J-12, Dubai, U.A.E. Phone:+971-4-299-5900 Fax:+971-4-299-5901

TOPCON CORPORATION

75-1 Hasunuma-cho,Itabashi-ku,Tokyo,174-8580 Japan.

Phone:3-3558-2520 Fax:3-3960-4214 www.topcon.co.jp

40508 91015

Printed in Japan 1008-100TH ©