

PSL Classic PSL One

PORTABLE SLIT LAMP

INSTRUCTIONS FOR USE



Keeler
– A world without vision loss –

CONTENTS

1. INDICATIONS FOR USE	3
2. SAFETY.....	4
2.1 PHOTOTOXICITY	4
2.2 WARNINGS AND CAUTIONS	4
2.3 CONTRAINDICATION.....	5
3. CLEANING AND DISINFECTION INSTRUCTIONS.....	6
4. NAMES OF CONTROLS AND COMPONENTS	6
5. INSTRUCTIONS FOR USE	8
5.1 PREPARING THE POWER SUPPLY AND THE BASE UNIT	8
5.2 PREPARING THE PORTABLE SLIT LAMP PRIOR TO USE	8
5.3 PREPARING THE PATIENT.....	9
6. PROBLEM SOLVING	10
7. ROUTINE MAINTENANCE	10
7.1 CHANGING THE LED.....	10
7.2 REGULARLY INSPECT THE DEVICE FOR DAMAGE OR DIRT.....	11
8. WARRANTY	11
9. SPECIFICATIONS AND ELECTRICAL RATINGS.....	11
9.1 ELECTROMAGNETIC EMISSIONS.....	12
9.2 ELECTROMAGNETIC IMMUNITY	12
9.3 RECOMMENDED SAFE DISTANCES	14
9.4 TECHNICAL SPECIFICATIONS.....	15
10. ACCESSORIES AND SPARES.....	17
11. PACKAGING AND DISPOSAL INFORMATION.....	17

	Consult instructions for use		General warning sign
	Date of manufacture		Warning: Electricity
	Manufacturer's name and address		Warning: Floor level obstacle
	Country of manufacture		Warning: Non-ionizing radiation
	Waste Electrical and Electronic Equipment (WEEE) recycling		Warning: Optical radiation
	This way up		Warning: Hot surface
	Keep dry		Conformité Européene
	Fragile		Type B applied part
	Do not use if package is damaged		Class II equipment
	Temperature limit		Atmospheric pressure limitation
	Authorised representative in the European Community		Humidity limitation
	Use-by date		Serial number
	Catalogue number		Medical device
	Translation		

The Keeler Portable Slit Lamp is designed and built in conformity with Directive 93/42/EEC, Regulation (EU) 2017/745 and ISO 13485 Medical Devices Quality Management Systems.

Classification: CE: Class I

FDA: Class II

The information contained within this manual must not be reproduced in whole or part without the manufacturer's prior written approval. As part of our policy for continued product development we the manufacturer reserve the right to make changes to specifications and other information contained in this document without prior notice.

This IFU is also available on the Keeler UK and Keeler USA websites.

Copyright © Keeler Limited 2021. Published in the UK 2021.

1. INDICATIONS FOR USE

This device is intended to be used only by suitably trained and authorised healthcare professionals.



CAUTION: Federal Law restricts this device to sale by or on the order of a physician or practitioner.

Intended use / purpose of instrument

The Keeler Portable Slit Lamp facilitates an examination of the anterior segment, or frontal structures and posterior segment, of the human eye, which includes the eyelid, sclera, conjunctiva, iris, natural crystalline lens and cornea which is accomplished through its lamp. PSL Classic provides x16 magnification setting in addition to the fixed x10 magnification that's only present on the PSL One variant.

Brief description of the instrument

The Keeler Portable Slit Lamp comprises a rechargeable hand held portable illuminated biomicroscope system and a desk mounted base charger unit that is powered from a low voltage (12V) power supply.

The hand-held unit incorporates a lithium ion rechargeable battery powering the illumination system. The illumination system and fixation targets are activated using a double click trigger located on the front of the grip / handle. To increase or reduce the light intensity there is a rheostat located below the eyepieces on the rear of the grip / handle.

PSL Classic

The 10x and 16x magnification optical system is controlled using a flip lever located under the adjustable eyepieces.

PSL One

The PSL One is a fixed 10x magnification system.

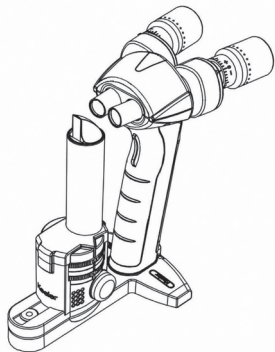
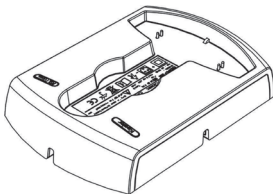

2. SAFETY

2.1 PHOTOTOXICITY



CAUTION: The light emitted from this instrument is potentially hazardous. The longer the duration of exposure, the greater the risk of ocular damage. Exposure to light from this instrument when operated at maximum intensity will exceed the safety guideline after 13 minutes for the LED version and after 44 minutes for the bulb version.



While no acute optical radiation hazards have been identified for slit lamps, we recommend keeping the intensity of the light reaching the patient's retina to the minimum possible for the respective diagnosis. Children, people with aphakia and people suffering from eye conditions are most at risk. An increased risk may also occur if the retina is exposed to the same or a similar device with a visible light source within 24 hours. This applies, in particular, if the retina has been photographed with a flashbulb in advance.

Keeler Ltd shall on request, provide the user with a graph showing the relative spectral output of the instrument.

2.2 WARNINGS AND CAUTIONS

Please note that the proper and safe functioning of our instruments is only guaranteed if both the instruments and their accessories are exclusively from Keeler Ltd. The use of other accessories may result in increased electromagnetic emissions or reduced electromagnetic immunity of the device and may lead to incorrect operation.

Observe the following precautions in order to ensure safe operation of the instrument.



WARNINGS

- Never use the instrument if visibly damaged and periodically inspect it for signs of damage or misuse.
- Check your Keeler product for signs of transport / storage damage prior to use.
- Do not use in the presence of flammable gases / liquids, or in an oxygen rich environment.
- US Federal Law restricts this device to sale by or on the order of a physician or practitioner.
- This device is intended to be used only by suitably trained and authorised healthcare professionals.
- This product should not be immersed in fluid.
- Repairs and modifications to the instrument must be made only by the specialized technicians of the manufacturer's Technical Service Centre or by personnel trained and authorised by the manufacturer. The manufacturer declines any and all responsibility for loss and/or damages resulting from unauthorised repairs; furthermore, any such actions will invalidate the warranty.

- The power switch and mains plug are the means of isolating the device from the mains supply – ensure both the power switch and mains plug are accessible at all times.
- Do not position the equipment so that is difficult to press the power switch or remove the mains plug from the wall socket.



- Route power cords safely to eliminate risk of tripping or damage to user.



- Before any cleaning of the instrument or the base unit ensure the power lead is disconnected.



- LEDs can reach high temperatures in use – allow to cool before handling.



- Do not exceed maximum recommended exposure time.

- Should the instrument suffer shocks (for example, should it accidentally fall), and the optical system or the illumination system are damaged it may be necessary to return the instrument to the manufacturer for repair.
- After removal of the LED, do not touch the Slit Lamp LED electrical contacts and patient simultaneously.
- The owner of the instrument is responsible for training personnel in its correct use.
- Ensure the instrument or instrument table is placed on a level and stable surface.
- Do not position the portable slit lamp such that it makes it difficult to access and operate the device.
- Applied parts exceed 41 degrees Celsius. The maximum temperature and condition of safe contact for the PSU is 44.3 degrees and the slit lamp base is 42.1 degrees.
- Use only genuine Keeler approved parts and accessories or device safety and performance may be compromised.
- For indoor use only (protect from moisture).
- Electrical equipment can be affected by electromagnetic interference. If this occurs whilst using this equipment, switch the unit off and reposition.



Before use, the Portable Slit Lamp should be allowed to adjust to the ambient room temperature for several hours. This is especially important when the unit has been stored or transported in a cold environment; this can cause severe condensation to develop on the optical elements.

2.3 CONTRAINDICATION

There is no restriction to the patient population this device can be used with. There are also no contraindications for this device.

3. CLEANING AND DISINFECTION INSTRUCTIONS



Before any cleaning of the instrument or the base unit, ensure the power lead is disconnected.

Only manual non-immersion cleaning as described should be used for this instrument. Do not autoclave or immerse in cleaning fluids. Always disconnect power supply from source before cleaning.

1. Wipe the external surface with a clean absorbent, non-shedding cloth dampened with de-ionised water / detergent solution (2% detergent by volume) or water / isopropyl alcohol solution (70% IPA by volume). Avoid optical surfaces.
2. Ensure that excess solution does not enter the instrument. Use caution to ensure cloth is not saturated with solution.
3. Surfaces must be carefully hand-dried using a clean non- shedding cloth.
4. Safely dispose of used cleaning materials.

4. NAMES OF CONTROLS AND COMPONENTS

Portable Slit Lamp illumination body and magnification optics

1. Trigger: Click and hold the trigger to turn the lamp illumination on. Double click (similarly to a computer mouse button) to turn both the illumination lamp and fixation targets on. Release the trigger to turn off the device.
2. Prism optical body: Projects a thin sheet (slit) of light perpendicular to the prism face.
3. Eyepieces – dioptical adjustment: Rotate clockwise to achieve a + (plus) setting and anti-clockwise for a – (minus) setting.
4. Eyepieces – PD adjustment: Rotate the left eyepiece anti-clockwise and the right eyepiece clockwise to increase the PD value. Rotate the left eyepiece clockwise and the right eyepiece anti-clockwise to decrease the PD value.
5. Latex free protective sleeves: These sleeves can be folded forwards to better suit spectacle wearers.
6. Fixation targets: Provides a light source for the patient to focus upon. Double click (similarly to a computer mouse button) to turn both the illumination lamp and fixation targets on.
7. Objective lenses: These lenses are flush with the external surface at a magnification of 10x and protrude from the device at a magnification of 16x.
8. Slit wheel: Rotate the slit wheel to select either a slit of 0.15mm (0.15), 0.5mm (0.5), 0.8mm (0.8), 1.6mm (1.6), a circle of 12mm (O), or a square of 1mm (□) for a/c flare assessment. (The text in the brackets corresponds to the icons on the slit wheel.)
9. Filter wheel: Rotate the filter wheel to select either a red free (R.F), blue (B.F), neutral density (N.D) or clear filter (O). (The text in the brackets corresponds to the icons on the filter wheel.)

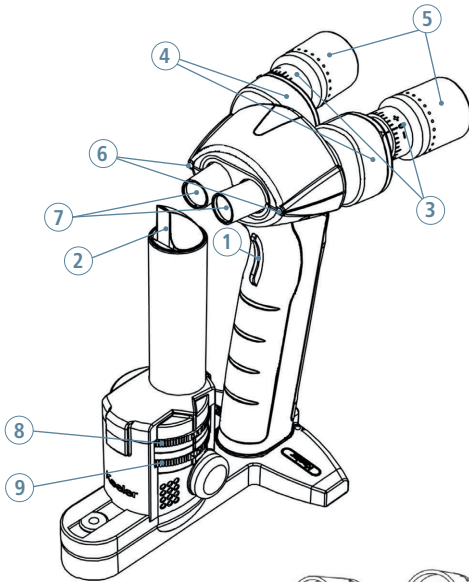

10. Magnification change lever (PSL Classic only): Push this lever to the right to set the magnification at 10x and to the left to set the magnification at 16x.
11. Alternative power socket: In addition to charging through the base charger unit, the device can also be charged through this socket.
12. Charging LED: The yellow charging LED is on continuously during normal charging and blinks when trickle charging. Trickle charging can occur at the start of charging a completely discharged battery or when attempting to charge a completely charged battery.
13. Battery state LED: The yellow battery state LED blinks when the battery is almost empty.

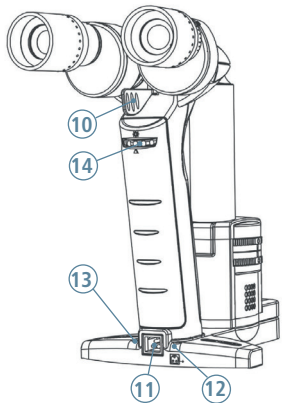

- Brightness adjustment wheel: Rotating this wheel clockwise increases the brightness of the illumination lamp. Rotating this wheel anti-clockwise decreases the brightness of the illumination lamp.

Portable Slit Lamp base charger unit

- Power socket for Keeler 12V Power Supply: Connect the power supply cable to this socket and place the slit lamp body in the charger unit to recharge the device.
- Recharging connection pins: Connects the slit lamp body to the charger unit to charge the device.
- Recess for slit lamp body: Place the slit lamp body in the charger unit when not in use.
- Grooves for power cable: Place the power supply cable in the most suitable groove to keep the unit tidy.
- Protective rubber feet: Ensures the surface onto which the charger unit is placed does not become scratched.
- Charging safety feature: Note: No electrical power is conducted through the pins (16) until the slit lamp body is placed into the recess of the charger unit.

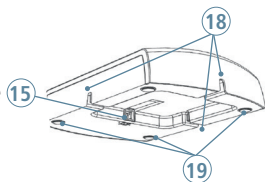
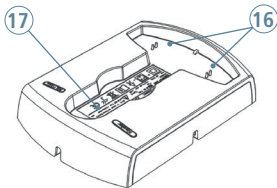

5. INSTRUCTIONS FOR USE

5.1 PREPARING THE POWER SUPPLY AND THE BASE UNIT

- Attach the appropriate mains plug adapter to the transformer after removing the blanking plate or if required use an IEC 60320 type 7 connector (not supplied).
- Connect the output power supply cable to the socket on the underside of the recharging base unit.
- Place the Portable Slit Lamp on the base charger unit, the yellow LED will illuminate to indicate the unit is being charged. From fully discharged to fully charged usually takes 2.5 hours.

Illumination 'on time' 50 minutes (when used at full intensity from fully charged)

5.2 PREPARING THE PORTABLE SLIT LAMP PRIOR TO USE

- Set the pupillary distance of the eyepieces by firmly grasping them and adjusting the distance by gently rotating the prism bodies inwards or outwards until a full circular image is seen binocularly.

- Adjust the dioptic power of each of the eyepieces, one at a time. Adjust the eyepiece to it's highest + (plus) setting and looking through the optics at the peripheral focus marker, slowly adjust the eyepiece towards the – (minus) setting until the focus marker is sharply in focus. Repeat this for the other eyepiece.

Note: Spectacle wearers may prefer to fold the rubber eye cup forwards.

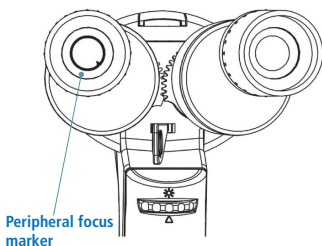

- Set the magnification to either x10 or x16 using the magnification change lever (PSL Classic only).
- Select your preferred slit width and filter by rotating the slit and the filter wheels.
- To set the slit at an angle rotate the illumination tower about its pivot axis.
- Holding the slit lamp firmly click and hold the trigger to turn on the illumination lamp. Double click and hold the trigger to turn on both the illumination lamp and fixation targets. The lamp does not run continuously, after a duration of 2 minutes it automatically switches off. This is the duration of safe contact.

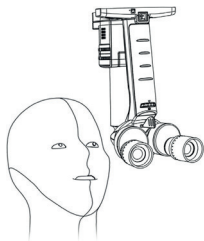

Note – for very small or young patients, babies in arms and some animals, sometimes it may be preferable to use the Portable Slit Lamp inverted – shown in the illustration.



Note – it can be beneficial to stabilize the Slit Lamp using the technique shown in the illustration above.

5.3 Preparing the patient

The patient should be as comfortable as possible and positioned to allow easy access to the eye to be examined.

The Keeler Portable Slit Lamp is designed to be ambidextrous, hold the Slit Lamp in your preferred hand simultaneously squeezing the trigger on / off switch.

To improve stability, especially at higher magnifications, you may like to use your other hand as a 'bridge' between the Slit Lamp body and the patient.

As with other Slit Lamp examination procedures it may be necessary to elevate the patient's eyelid.

6. PROBLEM SOLVING

Problem	Solution
No illumination, or low illumination	Check the unit is fully charged
	Check the position of the filters and slits to ensure they are set correctly
	Check and if necessary change the LED
Slit slanted at an angle	Check the position of the slit disc, it may not be located correctly at a slit position
Circle incomplete or offset	Check the position of the slit and filter discs, it may not be located correctly at a slit position
Poor focus	Check the dioptic settings of the eyepieces

7. ROUTINE MAINTENANCE

7.1 CHANGING THE LED



Warning the LED may be hot if the Slit Lamp has been in continuous use, take care when removing the LED.

Make sure the power is disconnected before changing the LED. To change the LED, first allow 5 minutes for it to cool down if the Slit Lamp has been in use.

1. Unscrew the black plastic LED cover by turning anti-clockwise.
2. Remove the old LED, allow 5 minutes for it to cool down if the Slit Lamp has been in use.
3. Insert the new LED, ensuring the notch is facing upwards as shown.

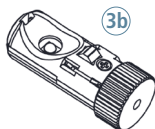
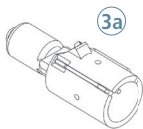
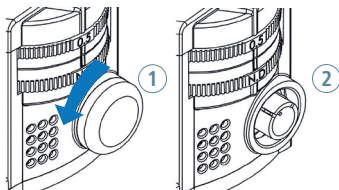

LED (1030-P-5002-001) for use with PSL's that have serial number 3010/18183 and above.

LED (1030-P-5002) for use with PSL's that have serial number 3010/00000 to S/N 3010/18182.

7.2 REGULARLY INSPECT THE DEVICE FOR DAMAGE OR DIRT

1. Routinely clean as per section 3 on page 6 cleaning instructions.
2. Care must be taken to keep the objective and the eyepiece lenses clean – use only soft, clean lens cloths to clean optical surfaces.



CAUTION: No specific frequency of servicing is applicable. Calibration, maintenance checks to be made only if the product has been dropped or suspected sign of damage for preventive inspection to be looked into.

8. WARRANTY

The Keeler Portable Slit Lamps are guaranteed for three years against faulty workmanship materials or factory assembly. Warranty is on a Return To Base (RTB) basis at the cost of the customer and may be void if the Slit Lamp has not been regularly serviced.

The manufacturer's warranty and terms and conditions are detailed on the Keeler UK website.

The mirror, main illumination lamp and general 'wear and tear' are excluded from our standard warranty.



The manufacturer declines any and all responsibility and warranty coverage should the instrument be tampered with in any manner or should routine maintenance be omitted or performed in manners not in accordance with these manufacturer's instructions.

There are no user serviceable parts in this instrument. Any servicing or repairs should only be carried out by Keeler Ltd. or by suitably trained and authorised distributors. Service manuals will be available to authorised Keeler service centres and Keeler trained service personnel.

9. SPECIFICATIONS AND ELECTRICAL RATINGS

The Keeler Portable Slit Lamp is a medical electrical instrument. The instrument requires special care concerning electromagnetic compatibility (EMC). This Section describes its suitability in terms of electromagnetic compatibility of this instrument. When installing or using this instrument, please read carefully and observe what is described here.

Portable or mobile-type radio frequency communication units may have an adverse effect on this instrument, resulting in malfunctioning.

9.1 ELECTROMAGNETIC EMISSIONS

Guidance and manufacturer's declaration – electromagnetic emissions

The Keeler Portable Slit Lamp is intended for use in the electromagnetic environment specified below. The customer or user should ensure that it is used in such an environment.

Emissions test	Compliance	Electromagnetic environment – guidance
RF emissions CISPR 11	Group 1	The Keeler Portable Slit Lamp uses RF energy only for its internal function. Therefore, its RF emissions are very low and are not likely to cause any interference in nearby electronic equipment.
RF emissions CISPR 11	Class A	The Keeler Portable Slit lamp is suitable for use in a professional healthcare facility environment. The Keeler Slit lamp is not intended for use in home environment.
Harmonic emissions IEC 61000-3-2	Class A	
Voltage fluctuations / flicker emissions IEC 61000-3-3	Complies	

9.2 ELECTROMAGNETIC IMMUNITY

Guidance and manufacturer's declaration – electromagnetic immunity

The Keeler Portable Slit Lamp is intended for use in the electromagnetic environment specified below. The customer or user should ensure that it is used in such an environment.

Immunity test	IEC 60601 Test level	Compliance level	Electromagnetic environment – guidance
Electrostatic discharge (ESD). IEC 6100-4-2	± 8 kV contact ± 15 kV air	± 8 kV contact ± 15 kV air	Floors should be wood, concrete or ceramic tile. If floors are covered with synthetic material, the relative humidity should be at least 30%
Electrical fast transient/burst. IEC 61000-4-4	± 2 kV for power supply lines ± 1 kV for power supply lines	± 2 kV for power supply lines ± 1 kV for input/output lines	Mains power quality should be that of a typical replace with professional healthcare facility
Surge. IEC 61000-4-5	± 1 kV line(s) to line(s) ± 2 kV line(s) for input/output line(s)	± 1 kV line(s) to line(s) ± 2 kV line(s) for input/output line(s)	Mains power quality should be that of a typical replace with professional healthcare facility

Immunity test	IEC 60601 Test level	Compliance level	Electromagnetic environment – guidance
Voltage dips, short interruptions and voltage variations on power supply input lines. IEC 61000-4-11	$U_T = 0\%$ 0.5 cycle (0, 45, 90, 135, 180, 225, 270, 315°) $U_T = 0\%$; 1 cycle $U_T = 70\%$; 25/30 cycles (@ 0°) $U_T = 0\%$; 250/300 cycle	$U_T = 0\%$ 0.5 cycle (0, 45, 90, 135, 180, 225, 270, 315°) $U_T = 0\%$; 1 cycle $U_T = 70\%$; 25/30 cycles (@ 0°) $U_T = 0\%$; 250/300 cycle	Mains power quality should be that of a typical professional healthcare facility environment. If the user of the Keeler Portable Slit Lamp requires continued operations during power mains interruptions, it is recommended that the instrument be powered from an uninterruptible power supply.
Power frequency (50/60 Hz) Magnetic field. IEC 61000-4-8	30 A/m	30 A/m	Power frequency magnetic fields should be at a level characteristic of a typical location in a typical professional healthcare facility environment.

Note: U_T is the a. c. mains voltage prior to application of the test level.

Immunity test	IEC 60601 Test level	Compliance level	Electromagnetic environment – guidance
			Portable and mobile RF communications equipment should be used no closer to any part of the Keeler Portable Slit Lamp, including cables, than the recommended separation distances calculated from the equation applicable to the frequency of the transmitter.
			Recommended separation distance
Conducted RF IEC 61000-4-6	6 Vrms	6 V	$d = 1.2 \sqrt{p}$
Radiated RF IEC 61000-4-3	10 V/m 80MHz to 2.7GHz	10 V/m	$d = 1.2 \sqrt{p}$ 80MHz to 800 MHz $d = 2.3 \sqrt{p}$ 800MHz to 2.7GHz

			<p>Where p is the maximum output power rating of the transmitter in watts (W) according to the transmitter manufacturer and d is the recommended separation distance in metres (m).</p> <p>Field strengths from fixed RF transmitters, as determined by an electromagnetic site survey¹, should be less than the compliance level in each frequency range.²</p> <p> Interference may occur in the vicinity of equipment marked with this symbol.</p>
--	--	--	---

Note 1: At 80MHz and 800MHz, the higher frequency range applies.

Note 2: These guide lines may not apply in all situations. Electromagnetic propagation is affected by absorption and reflection from structures, objects and people.

1 Field strengths from fixed transmitters, such as base stations (cellular / cordless) telephones and land mobile radios, amateur radio, AM and FM radio broadcast and TV broadcast cannot be predicted theoretically with accuracy. To assess the electromagnetic environment due to fixed RF transmitters, an electromagnetic site survey should be considered. If the measured field strength in the location in which the Keeler Portable Slit Lamp is used exceeds the applicable RF compliance level above, the Keeler Portable Slit Lamp should be observed to verify normal operation. If abnormal performance is observed, additional measures may be necessary, such as re-orientating or relocating the Keeler Portable Slit Lamp.

2 Over the frequency range 150kHz to 80 MHz, field strengths should be less than 10 V/m.

9.3 RECOMMENDED SAFE DISTANCES

Recommended separation distances between and mobile RF communications equipment and the Keeler Portable Slit Lamp

The Keeler Portable Slit Lamp is intended for the use in an electromagnetic environment in which radiated RF disturbances are controlled. The customer or the user of the Keeler Portable Slit Lamp can help prevent electromagnetic interference by maintaining a minimum distance between mobile RF communications equipment (transmitters) and the Keeler Portable Slit Lamp as recommended below, according to the maximum output power of the communications equipment.

Rated maximum output power of transmitter (W)	Separation distance according to frequency of transmitter (m)		
	150 kHz to 80MHz $d = 1.2\sqrt{p}$	80MHz to 800MHz $d = 1.2\sqrt{p}$	800MHz to 2.7GHz $d = 2.3\sqrt{p}$
0.01	0.12	0.12	0.23
0.1	0.38	0.38	0.73
1	1.2	1.2	2.3
10	3.8	3.8	7.3
100	12	12	23

For transmitters rated at a maximum output power not listed above, the recommended separation distance in metres (m) can be determined using the equation applicable to the frequency of the transmitter, where p is the maximum output power rating of the transmitter in watts (W) according to the transmitter manufacturer.

Note: At 80MHz and 800MHz, the separation distance for the higher frequency applies.

These guidelines may not apply in all situations. Electromagnetic propagation is affected by absorption and reflection from structures, objects and people.

9.4 TECHNICAL SPECIFICATIONS

Biomicroscope

Type	Binocular Handheld Biomicroscope Slit Lamp		
Optics	Converging binoculars at 13°		
Magnification	PSL One: 10x fixed PSL Classic: 10x and 16x, lever change		
Objective lens working distance @ 10x	100mm	PSL One	PSL Classic
Objective lens working distance @ 16x	80mm		PSL Classic
Field of view @ 10x	16mm	PSL One	PSL Classic
Field of view @ 16x	10.5mm		PSL Classic
	34, 22, 14, 8.5 and 5.5 mm 22, 14 & 8.5mm		
PD range	50mm to 72mm		
Eyepiece dioptric adjustment range	± 7 Dioptres		
Size: Hand held device	238 x 116 x 210 mm		
Size: Docking station	205 x 138 x 40 mm		
Weight: Hand held device	~900g		
Weight: Docking station	300g		

Slit and filter system

Slit type	Rotating Slit Wheel Selection Slit Lamp
Slit Width	0.15mm, 0.5mm, 0.8mm and 1.6mm slits, 12mm circle and a 1mm square
Slit Length	12mm
Filters	Red free, Blue, Neutral density 0.8 and Clear
IR protection	Inbuilt IR cut filter
Slit angle	± 60°
Illumination control	Continuously variable from low to full brightness

Contact



Manufacturer

Keeler Limited
Clewer Hill Road
Windsor
Berkshire
SL4 4AA UK

Freephone 0800 521251

Tel +44 (0) 1753 857177

Fax +44 (0) 1753 827145

USA Sales Office

Keeler USA
3222 Phoenixville Pike
Building #50
Malvern, PA 19355 USA
Toll Free 1 800 523 5620
Tel 1 610 353 4350
Fax 1 610 353 7814

India Office

Keeler India
Halma India Pvt. Ltd.
Plot No. A0147, Road No. 24
Wagle Industrial Estate
Thane West – 400604, Maharashtra
INDIA
Tel +91 22 4124 8001

China Office

Halma China Group
名称：沃迈（上海）机电有限公司
地址：上海市闵行区金都路1165弄
123号23幢一号厂房三层B座
电话：021-6151 9025



Visiometrics, S. L., Vinyals, 131
08221 Terrassa, Spain

EP59-59992 Issue A

Date of Issue 12/05/2021